



# Service Manual

Models: 81 - 286



**⚠ WARNING**

This manual must only be used by a qualified heating installer / service technician. Read all instructions, including this manual and the Knight Boiler Installation and Operation Manual, before installing. Perform steps in the order given. Failure to comply could result in severe personal injury, death, or substantial property damage.



Save this manual for future reference.

# Contents

<b>CONTENTS</b> .....	2	<b>2. MAINTENANCE</b>	
Hazard Definitions.....	2	Maintenance and Annual Startup.....	28-32
<b>PLEASE READ BEFORE PROCEEDING</b> .....	3	<b>3. TROUBLESHOOTING</b>	
Handling Ceramic Fiber Materials.....	3	Before Troubleshooting.....	33
When servicing boiler .....	4	Check Control Module Fuses .....	33
Boiler operation.....	4	Table 3-1 - Troubleshooting Chart - No Display .....	34
Boiler water.....	4	Checking Temperature Sensors .....	35
Freeze protection fluids .....	4	Table 3-3 - Troubleshooting Chart - Noisy System .....	36
WHAT IS IN THIS MANUAL .....	5	Table 3-4 - Troubleshooting Chart - Fault Messages .	37-46
<b>1. SERVICE</b>		Combustion Analysis Procedure .....	46
Near Boiler Piping .....	6	Table 3-5 - Flue Products .....	46
The Knight Boiler Display.....	7	Table 3-6 - Troubleshooting Chart - Combustion Levels	47
Control Inputs .....	8	Gas Valve Adjustment Procedure.....	47
Control Outputs.....	9	Revision Notes .....	Back Cover
General Operation .....	10		
Sequence of Operation .....	11-12		
Display Panel Menu Access .....	13		
Display Panel Parameter Access.....	14		
Parameter Table.....	15-18		
Viewable and Changeable Control Parameters.....	19-27		

---

## Hazard definitions

The following defined terms are used throughout this manual to bring attention to the presence of hazards of various risk levels or to important information concerning the life of the product.

**⚠ DANGER** DANGER indicates an imminently hazardous situation which, if not avoided, will result in death or serious injury.

**⚠ WARNING** WARNING indicates a potentially hazardous situation which, if not avoided, could result in death or serious injury.

**⚠ CAUTION** CAUTION indicates a potentially hazardous situation which, if not avoided, may result in minor or moderate injury.

**CAUTION** CAUTION used without the safety alert symbol indicates a potentially hazardous situation which, if not avoided, may result in property damage.

**NOTICE** NOTICE indicates special instructions on installation, operation, or maintenance that are important but not related to personal injury or property damage.

## Please read before proceeding

**⚠ WARNING**

**Installer** – Read all instructions, including this manual and the Knight Boiler Installation and Operation Manual, before installing. Perform steps in the order given.

**User** – This manual is for use only by a qualified heating installer/service technician. Refer to the Knight Boiler User's Information Manual for your reference.

Have this boiler serviced/inspected by a qualified service technician at least annually.

Failure to comply with the above could result in severe personal injury, death or substantial property damage.

**NOTICE**

When calling or writing about the boiler – Please have the boiler model and serial number from the boiler rating plate.

Consider piping and installation when determining boiler location (see the Knight Boiler Installation and Operation Manual).

Any claims for damage or shortage in shipment must be filed immediately against the transportation company by the consignee.

## Handling ceramic fiber materials

### REMOVAL OF COMBUSTION CHAMBER LINING

**⚠ WARNING**

The combustion chamber insulation in this appliance contains ceramic fiber material. Ceramic fibers can be converted to cristobalite in very high temperature applications. The International Agency for Research on Cancer (IARC) has concluded, "Crystalline silica in the form of quartz or cristobalite from occupational sources is carcinogenic to humans (Group 1)." Normal operating temperatures in this appliance are below the level to convert ceramic fibers to cristobalite. Abnormal operating conditions would have to be created to convert the ceramic fibers in this appliance to cristobalite.

The ceramic fiber material used in this appliance is an irritant; when handling or replacing the ceramic materials it is advisable that the installer follow these safety guidelines.

- Avoid breathing dust and contact with skin and eyes.
  - Use NIOSH certified dust respirator (N95). This type of respirator is based on the OSHA requirements for cristobalite at the time this document was written. Other types of respirators may be needed depending on the job site conditions. Current NIOSH recommendations can be found on the NIOSH website at <http://www.cdc.gov/niosh/homepage.html>. NIOSH approved respirators, manufacturers, and phone numbers are also listed on this website.
  - Wear long-sleeved, loose fitting clothing, gloves, and eye protection.
- Apply enough water to the combustion chamber lining to prevent airborne dust.
- Remove the combustion chamber lining from the appliance and place it in a plastic bag for disposal.
- Wash potentially contaminated clothes separately from other clothing. Rinse clothes washer thoroughly.

#### NIOSH stated First Aid.

- Eye: Irrigate immediately.
- Breathing: Fresh air.

## Please read before proceeding

### When servicing boiler –

- To avoid electric shock, disconnect electrical supply before performing maintenance.
- To avoid severe burns, allow boiler to cool before performing maintenance.

### Boiler operation –

- Do not block flow of combustion or ventilation air to the boiler.
- Should overheating occur or gas supply fail to shut off, do not turn off or disconnect electrical supply to circulator. Instead, shut off the gas supply at a location external to the appliance.
- Do not use this boiler if any part has been under water. The possible damage to a flooded appliance can be extensive and present numerous safety hazards. Any appliance that has been under water must be replaced.

### Boiler water –

- Thoroughly flush the system (without boiler connected) to remove sediment. The high-efficiency heat exchanger can be damaged by build-up or corrosion due to sediment.
- Do not use petroleum-based cleaning or sealing compounds in the boiler system. Gaskets and seals in the system may be damaged. This can result in substantial property damage.
- Do not use “homemade cures” or “boiler patent medicines”. Serious damage to the boiler, personnel, and/or property may result.
- Continual fresh make-up water will reduce boiler life. Mineral buildup in the heat exchanger reduces heat transfer, overheats the stainless steel heat exchanger, and causes failure. Addition of oxygen carried in by makeup water can cause internal corrosion. Leaks in boiler piping must be repaired at once to prevent the introduction of makeup water.

### Freeze protection fluids –

- NEVER use automotive antifreeze. Use only inhibited propylene glycol solutions which are specifically formulated for hydronic systems. Ethylene glycol is toxic and can attack gaskets and seals used in hydronic systems.

## What is in this manual?

### Service

#### Near boiler piping

- Typical system components

#### The Knight boiler display

- Display panel readout, buttons and their functions

#### Control module inputs

- Control module inputs and options

#### Control module outputs

- Control module outputs and options

### General

- How the boiler operates
- How the control module operates
- Access modes -- user and installer
- Sequence of operation -- Domestic Hot Water (DHW)/space heating

#### Control panel menu access

- Accessing programming mode and locating menus (See separate guide covering the PC interface.)

#### Control panel parameter access

- Accessing and changing parameters from the display panel

#### Quick start information -- parameter table

- An index of available adjustments and readouts, where to access them and where to find detailed information.

### Knight boiler operation

- General
- Temperature Setting
- Data Logging
- Functions
- DHW Settings
- Outdoor Reset
- Anti-cycling
- Control Modes
- Circulation Pumps
- Building Management System (BMS)
- Service Notification

### Maintenance

- Service and maintenance schedules
- Address reported problems
- Inspect boiler area and boiler interior
- Clean condensate trap
- Check all piping for leaks
- Check air openings
- Flue vent system and air piping
- Check water system
- Check expansion tank
- Check boiler relief valve
- Inspect ignition electrode
- Check ignition ground wiring
- Check all boiler wiring
- Check control settings
- Perform start-up and checks
- Check burner flame
- Check flame signal
- Check flue gas temperature
- General maintenance
- Review with owner
- Cleaning boiler heat exchanger
- Oiled bearing circulators

### Troubleshooting

- Troubleshooting table - No display
- Checking temperature sensors
- Sensor tables
- Troubleshooting table - Fault messages displayed on boiler interface
- Combustion analysis procedure
- Gas valve adjustment procedure

# 1 Service

## Near boiler piping

This piping reference is included to specify the *Near Boiler Piping* specific to the Knight boiler. This piping scheme is important for proper operation of the SMART SYSTEM control. See the Knight Boiler Installation and Operation Manual for more detailed piping diagrams.

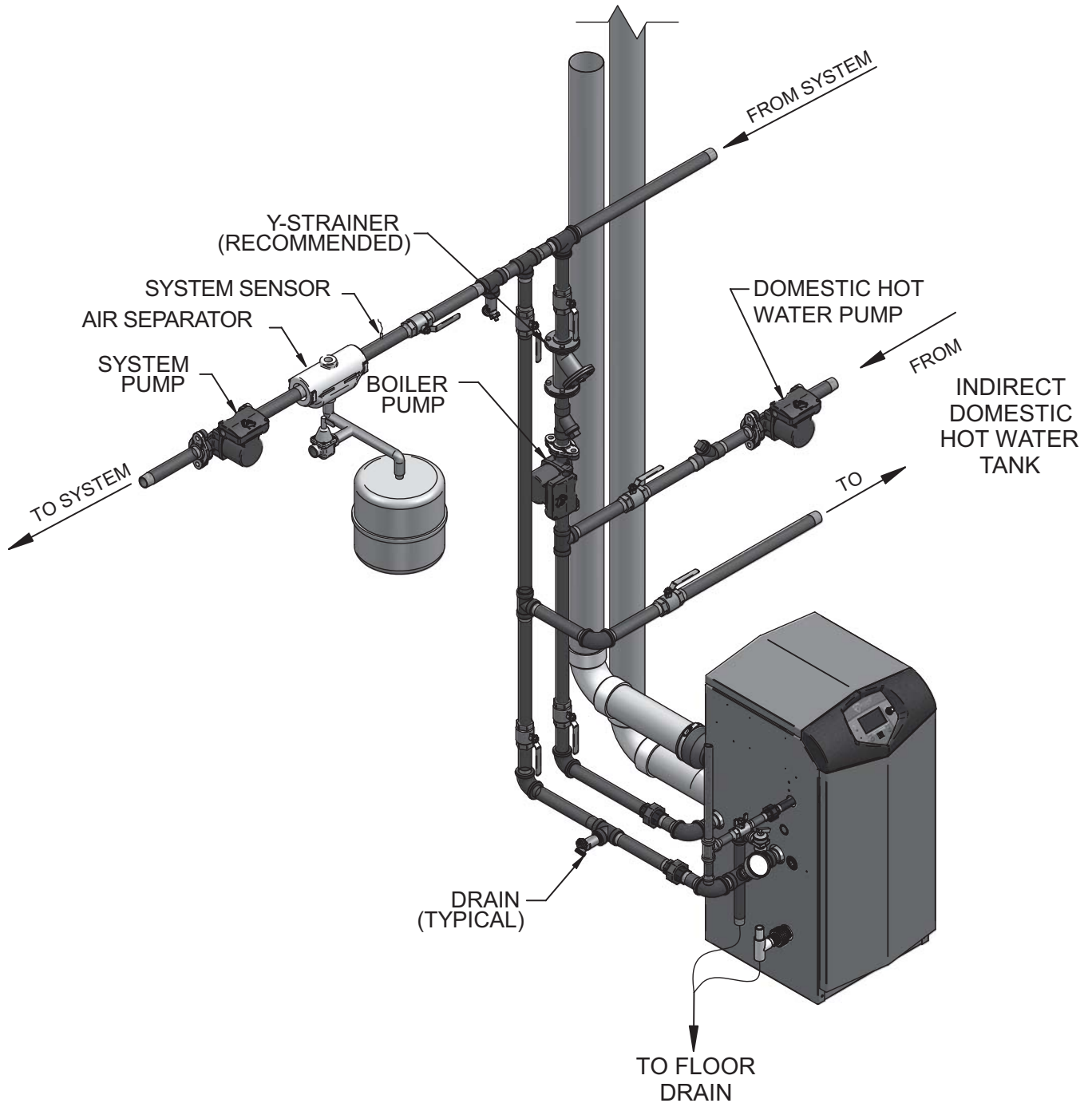

# 1 Service *(continued)*

## The Knight boiler display



The information on the bottom of the display shows the functions of the two SELECT keys (on either corner), and the NAVIGATION dial (in the center):

MENU = Left SELECT Key  
 SETPOINTS = NAVIGATION Dial - Pressing Down  
 SHDN = Right SELECT Key

# 1 Service

## Control inputs

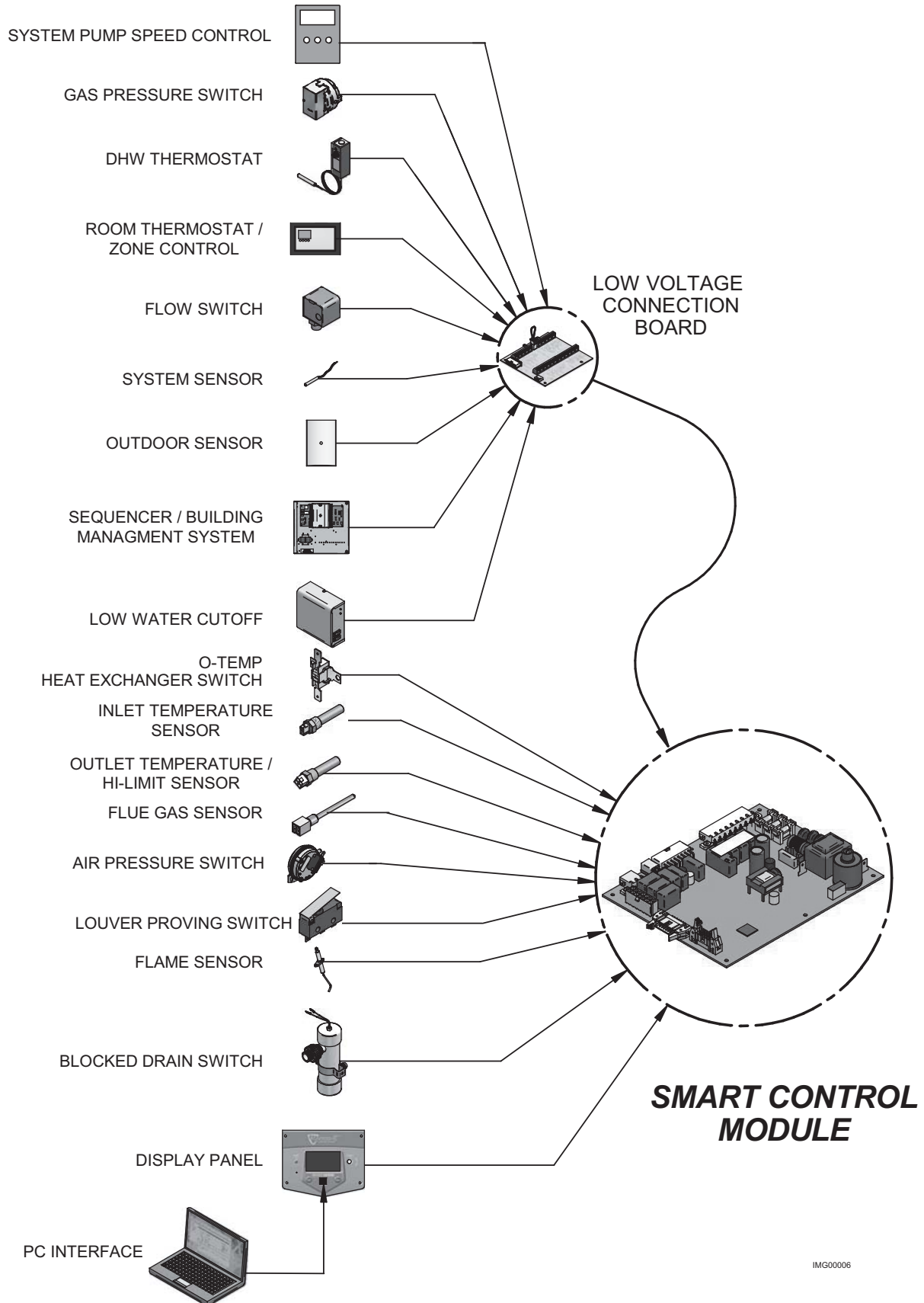

IMG00006



# 1 Service *(continued)*

## Control outputs

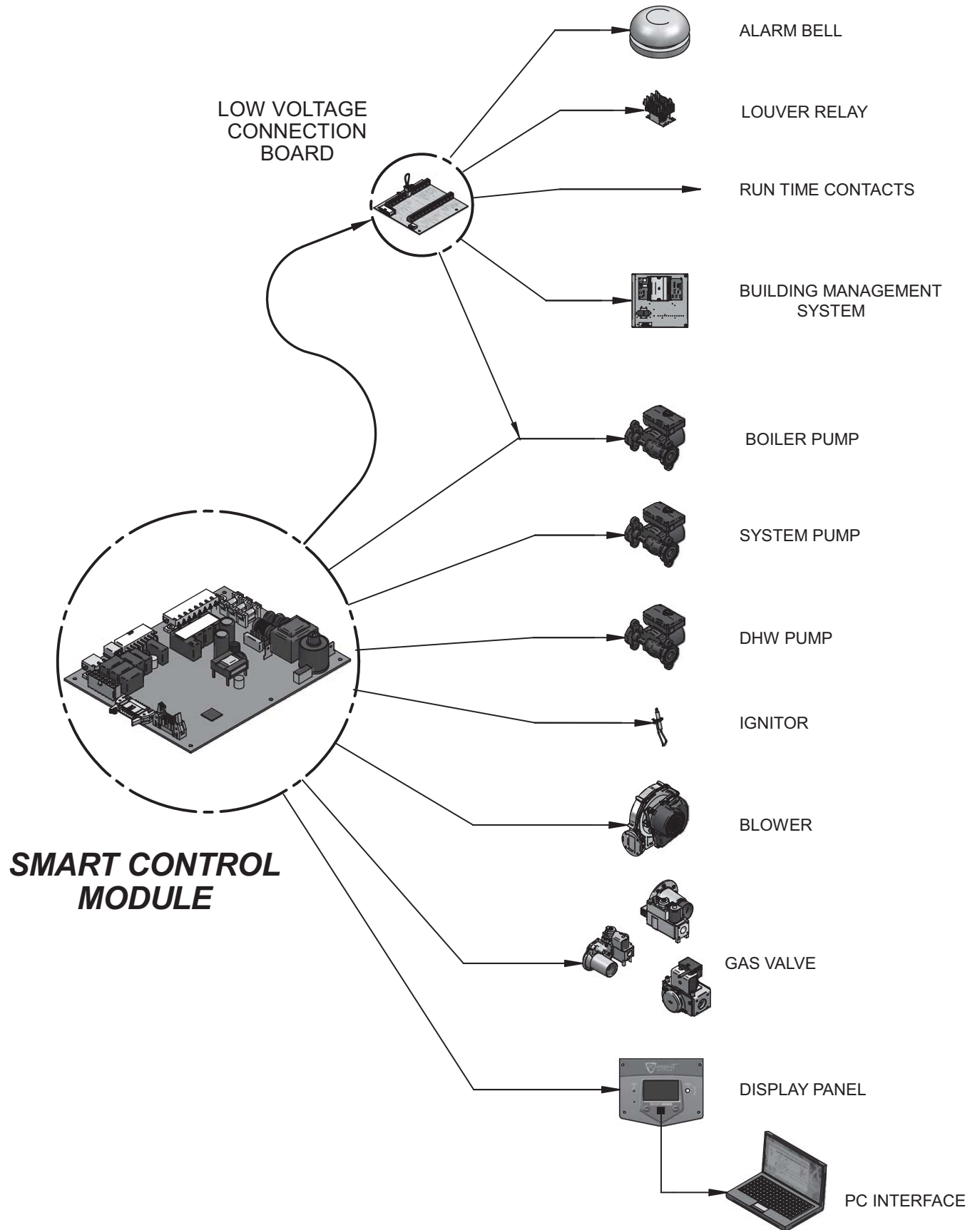

# 1 Service

## General Operation

### How the boiler operates

The Knight boiler uses an advanced stainless steel heat exchanger and an electronic control module that allows fully condensing operation. The blower pulls in gas and air and pushes flue products out of the boiler through the heat exchanger and flue piping. The control module regulates blower speed to control boiler firing rate. The gas valve senses the amount of air flowing into the boiler and allows only the right amount of gas to flow.

### How the control module operates

The Knight boiler control module receives input from boiler sensors. The control module activates and controls the blower and gas valve to regulate heat input and switches boiler, DHW and system pumps on and off as needed. The user/installer programs the module to meet system needs by adjusting control parameters. These parameters set operating temperatures and boiler operating modes. Boiler operation can be based on boiler outlet water temperature, boiler return water temperature or system supply temperature, depending on the parameter setting.

### Sequence of operation

Table 1-1 shows control module normal sequences of operation for space heating and DHW operation. The combined operation sequence is for a typical application, programmed to provide DHW priority.

## Access modes

### User

The user can adjust space heating and tank target temperatures by pressing the NAVIGATION dial when “↓SETPOINTS” is flashing at the bottom of the display. The date and time, and the temperature units can also be changed.

### Installer

Most parameters are available only to the installer, accessible only by entering the installer password (5309).

Saving parameters (*reference the Parameter Table - Table 1-4 on pages 15 - 18 of this manual*)

**NOTICE**

Please note that the brackets ([]) denote screen status.

### To save parameters and exit programming:





















Press the RIGHT SELECT [SAVE] key and then press the RIGHT SELECT [HOME] key.

### To enter a parameter and continue programming:

Press the RIGHT SELECT [SAVE] key 1 time to return to the parameter listings; press again to return to the menu listings. Remember to press the RIGHT SELECT [HOME] key when finished programming in order to save the changes made.

# 1 Service *(continued)*

**Table 1-1 Sequence of Operation**

OPERATION	DISPLAY
1. Upon a call for heat, the gas pressure switch(es) must be closed.	<p><b>PRE-PURGE</b> </p> <p>SYSTEM: 116°F                      TANK: 128°F(125)                      OUTDOOR: 56°F</p> <hr/> <p>MENU   SCREEN SHDN</p>
2. Once the gas pressure switch(es) are closed, the control turns on the appropriate pumps (system and boiler pumps for space heating, DHW pump for DHW). The flow switch and/or LWCO must close.	<p><b>PRE-PURGE</b> </p> <p>SYSTEM: 116°F                      TANK: 128°F(125)                      OUTDOOR: 56°F</p> <hr/> <p>MENU   SCREEN SHDN</p>
3. The control turns on power to the louver relay. The louver proving switch, air pressure switch, and blocked drain switch must close.	<p><b>PRE-PURGE</b> </p> <p>SYSTEM: 116°F                      TANK: 128°F(125)                      OUTDOOR: 56°F</p> <hr/> <p>MENU   SCREEN SHDN</p>
4. The control starts the prepurge cycle by initiating the blower.	<p><b>PRE-PURGE</b> </p> <p>SYSTEM: 117°F (118)                      TANK: 128°F (130)                      OUTDOOR: 56°F</p> <hr/> <p>MENU   SCREEN SHDN</p>
5. The control starts the trial for ignition by firing the spark electrode and opening the gas valve.	<p><b>IGNITION</b> </p> <p>SYSTEM: 117°F (118)                      DHW TANK: 128°F (130)                      OUTDOOR: 56°F</p> <hr/> <p>MENU   SCREEN SHDN</p>
6. If flame is not detected after the sparking ends, the control will perform a postpurge, then start another prepurge cycle and try to light the burner again. The control will perform a total of 4 attempts before locking out.	<p><b>POST-PURGE</b></p> <p>SYSTEM: 117°F (118)                      TANK: 128°F (130)                      OUTDOOR: 56°F</p> <hr/> <p>MENU   SCREEN SHDN</p>
7. If flame is detected, it holds the firing rate steady for a few seconds to let the flame stabilize, then it begins to modulate the firing rate based on a set point or some other command (such as a 0-10V BMS signal).	<p><b>42%</b>  </p> <p>SYSTEM: 117°F (118)                      TANK: 128°F (130)                      OUTDOOR: 56°F</p> <hr/> <p>MENU   SCREEN SHDN</p>

# 1 Service









**Table 1-1** (continued from previous page) *Sequence of Operation*

OPERATION	DISPLAY
8. If the space heating call for heat is active, and the tank thermostat or sensor starts a DHW call for heat, the boiler will switch to the DHW mode. If programmed for normal DHW operation (not as a zone), the DHW pump will turn on first, then the boiler pump will turn off 2 seconds later. This will divert the boiler's outlet water from the heating system and send it to the tank coil instead. The control will then modulate to maintain the outlet temperature to the DHW boiler set point.	<pre> 42% 🔥 1 🔧 SYSTEM: 117°F(118) TANK: 124°F(130) OUTDOOR: 56°F ----- MENU ⏪SCREEN SHDN                     </pre>
9. If the boiler is not part of a Cascade, and both the space heating and DHW calls for heat remain active long enough, the boiler will switch back and forth between the two heating modes until one of them is satisfied.	<pre> 42% 🔥 🏠 🔧 SYSTEM: 117°F(118) TANK: 124°F(130) OUTDOOR: 56°F ----- MENU ⏪SCREEN SHDN                     </pre>
10. Once both calls for heat are satisfied, the control will turn off the burner. The blower will continue to run during the postpurge period.	<pre> POST-PURGE SYSTEM: 117°F(118) TANK: 128°F(130) OUTDOOR: 56°F ----- MENU ⏪SCREEN SHDN                     </pre>
11. Any pumps that are running will continue to run for their respective pump delay times before turning off, unless programmed to remain on continuously. A 60 second anti-cycle period will start, which will delay any new call for heat until it times out.	<pre> BLOCKED SYSTEM: 117°F(118) TANK: 124°F(130) OUTDOOR: 56°F ----- MENU ⏪SCREEN SHDN                     </pre>
12. In Standby, ready to start a new cycle.	<pre> STANDBY SYSTEM: 117°F DHW TANK: 128°F(130) OUTDOOR: 56°F ----- MENU ⏩SETPOINTS SHDN                     </pre>

# 1 Service *(continued)*

## Display panel menu access









**Table 1-2** Use this procedure to access menus from the display panel

BUTTON	SCREEN STATUS	OPERATION	DISPLAY
	[SHDN]	Press the RIGHT SELECT soft key [SHDN].	<b>STANDBY</b> OUTLET            117°F INLET              128°F <hr/> MENU ↓SETPOINTS SHDN
	[YES]	Press the LEFT SELECT soft key [YES].	<b>STANDBY</b> SHUTDOWN <hr/> YES _____ NO
	[MENU]	Press and hold the LEFT SELECT soft key [MENU] for five (5) seconds.	<b>SHUTDOWN</b> INLET            117°F OUTLET           128°F <hr/> MENU ↓SETPOINTS SHDN
		Rotate the NAVIGATION dial clockwise until 5 is displayed (first digit on the left).	<b>SHUTDOWN</b> PASSWORD 0000 <hr/> EXIT    ↓NEXT    SAVE
		Press the NAVIGATION dial to select the next digit. Rotate the NAVIGATION dial clockwise until 3 is shown in the display.	<b>SHUTDOWN</b> PASSWORD 5000 <hr/> EXIT    ↓NEXT    SAVE
		Press the NAVIGATION dial 2 times to move to the last digit. Rotate the NAVIGATION dial counterclockwise until 9 is displayed.	<b>SHUTDOWN</b> PASSWORD 5300 <hr/> EXIT    ↓NEXT    SAVE
	[SAVE]	Press the RIGHT SELECT soft key [SAVE].	<b>SHUTDOWN</b> PASSWORD 5309 <hr/> EXIT    ↓NEXT    SAVE
		Rotate the NAVIGATION dial counterclockwise to select a category.	<b>SHUTDOWN</b> >GENERAL TEMPERATURE SETTINGS DATA LOGGING FUNCTIONS <hr/> HOME    ↵ SCROLL

# 1 Service

## Display panel parameter access

**Table 1-3** This is a typical example of accessing, adjusting, and saving a parameter, shown for parameter Temperature Settings, MIN SH Setpt

BUTTON	SCREEN STATUS	OPERATION	DISPLAY
<p><i>This example shows how to access parameter Temperature Settings. The first display shown is at the beginning of the menu listings, after entering the installer access code.</i></p>			
		Rotate the NAVIGATION dial counterclockwise until the arrow (>) is next to <b>TEMPERATURE SETTINGS</b> .	<b>SHUTDOWN</b> >GENERAL TEMPERATURE SETTINGS DATA LOGGING FUNCTIONS <hr/> HOME ↵ SCROLL
		Press the NAVIGATION dial one time.	<b>SHUTDOWN</b> GENERAL >TEMPERATURE SETTINGS DATA LOGGING FUNCTIONS <hr/> HOME ↵ SCROLL
		Rotate the NAVIGATION dial counterclockwise until the arrow (>) is next to <b>MIN SETPT</b> .	<b>SHUTDOWN</b> SH1 SETPT 180°F MIN SETPT 32°F MAX SETPT 190°F SH1 OFFSET 10°F <hr/> HOME ↵ SCROLL
		Press the NAVIGATION dial one time.	<b>SHUTDOWN</b> SH1 SETPT 180°F >MIN SETPT 32°F MAX SETPT 190°F SH1 OFFSET 10°F <hr/> HOME ↵ SCROLL
		Rotate the NAVIGATION dial to the desired temperature.	<b>SHUTDOWN</b> SH1 SETPT 180°F >MIN 32°F MAX SETPT 190°F SH1 OFFSET 10°F <hr/> EXIT ↵ ADJUST SAVE
	[SAVE]	Press the RIGHT SELECT soft key [SAVE] one time.	<b>SHUTDOWN</b> SH1 SETPT 180°F >MIN 32°F MAX SETPT 190°F SH1 OFFSET 10°F <hr/> EXIT ↵ ADJUST SAVE
	[EXIT]	Press the LEFT SELECT soft key [EXIT] if all desired changes have been made.	<b>SHUTDOWN</b> SH1 SETPT 180°F >MIN SETPT 32°F MAX 190°F SH1 10°F <hr/> EXIT ↵ SCROLL SAVE
	[HOME]	Press the LEFT SELECT soft key [HOME].	<b>SHUTDOWN</b> SH1 SETPT 180°F >MIN 32°F MAX SETPT 190°F SH1 OFFSET 10°F <hr/> HOME ↵ SCROLL

# 1 Service *(continued)*

## Parameter table

**Table 1-4** This table lists SMART SYSTEM control module parameters and where to access them

Menu	Description	See Page	User Access		Installer Access	
			Display	Modify	Display	Modify
GENERAL	Time and Date	19	Yes	Yes	Yes	Yes
	Software Version (read only)	19	No	No	Yes	No
	Temperature Units (°C/°F)	19	Yes	Yes	Yes	Yes
	SH Night Setback Offset	19	No	No	Yes	Yes
	SH Night Setback On Times	19	No	No	Yes	Yes
	SH Night Setback Off Times	19	No	No	Yes	Yes
	DHW Night Setback Offset	19	No	No	Yes	Yes
	DHW Night Setback On Times	19	No	No	Yes	Yes
	DHW Night Setback Off Times	19	No	No	Yes	Yes
	Display Timeout	20	No	No	Yes	Yes
TEMPERATURE SETTINGS	SH1 Set Point	20	Yes	Yes	No	No
	Minimum SH Set Point	20	No	No	Yes	Yes
	Maximum SH Set Point	20	No	No	Yes	Yes
	SH1 Offset	20	No	No	Yes	Yes
	SH1 Differential	20	No	No	Yes	Yes
	SH2 Set Point	20	Yes	Yes	No	No
	SH2 Offset	20	No	No	Yes	Yes
	SH2 Differential	20	No	No	Yes	Yes
	SH3 Set Point	20	Yes	Yes	No	No
	SH3 Offset	20	No	No	Yes	Yes
	SH3 Differential	20	No	No	Yes	Yes
	3-Way Valve Time	20	No	No	Yes	Yes
DATA LOGGING	Reset Log Errors	20	No	No	Yes	Yes
FUNCTIONS	Service Mode Delay	20	No	No	Yes	Yes
	Freeze Protection Pump On	20	No	No	Yes	Yes
	Freeze Protection Burner On	20	No	No	Yes	Yes
	Freeze Protection Burner Differential	21	No	No	Yes	Yes

# 1 Service

## Parameter table

**Table 1-4** (continued from previous page) This table lists SMART SYSTEM control module parameters and where to access them

Menu	Description	See Page	User Access		Installer Access	
			Display	Modify	Display	Modify
DHW SETTINGS	DHW Boiler Set Point	21	No	No	Yes	Yes
	Tank Set Point	21	Yes	Yes	Yes	Yes
	Tank Set Point Differential	21	No	No	Yes	Yes
	DHW Boiler Offset	21	No	No	Yes	Yes
	DHW Boiler Differential	21	No	No	Yes	Yes
	SH/DHW Switching Time	21	No	No	Yes	Yes
	DHW/SH Switching Time	21	No	No	Yes	Yes
	Tank Minimum Set Point	21	No	No	Yes	Yes
	Tank Maximum Set Point	21	No	No	Yes	Yes
	DHW Type	21	No	No	Yes	Yes
	Fan Speed Limiting for DHW	21	No	No	Yes	Yes
OUTDOOR RESET	Outdoor 1 Low	22	No	No	Yes	Yes
	Outdoor 1 High	22	No	No	Yes	Yes
	Set Point 1 at Low Outdoor Temp 1	22	No	No	Yes	Yes
	Set Point 1 at High Outdoor Temp 1	22	No	No	Yes	Yes
	Outdoor Air Shutdown SH1	22	No	No	Yes	Yes
	Outdoor Air Shutdown Differential SH1	23	No	No	Yes	Yes
	Shift Reset Curve SH1	23	No	No	Yes	Yes
	Outdoor 2 Low	22	No	No	Yes	Yes
	Outdoor 2 High	22	No	No	Yes	Yes
	Set Point 2 at Low Outdoor Temp 2	22	No	No	Yes	Yes
	Set Point 2 at High Outdoor Temp 2	22	No	No	Yes	Yes
	Outdoor Air Shutdown SH2	22	No	No	Yes	Yes
	Outdoor Air Shutdown Differential SH2	23	No	No	Yes	Yes
	Shift Reset Curve SH2	23	No	No	Yes	Yes
	Outdoor 3 Low	22	No	No	Yes	Yes
	Outdoor 3 High	22	No	No	Yes	Yes
	Set Point 3 at Low Outdoor Temp 3	22	No	No	Yes	Yes
	Set Point 3 at High Outdoor Temp 3	22	No	No	Yes	Yes
	Outdoor Air Shutdown SH3	22	No	No	Yes	Yes
	Outdoor Air Shutdown Differential SH3	23	No	No	Yes	Yes
Shift Reset Curve SH3	23	No	No	Yes	Yes	



# 1 Service *(continued)*

## Parameter table

**Table 1-4** (continued from previous page) This table lists SMART SYSTEM control module parameters and where to access them

Menu	Description	See Page	User Access		Installer Access	
			Display	Modify	Display	Modify
OUTDOOR RESET	Boost Temperature	23	No	No	Yes	Yes
	Boost Time	23	No	No	Yes	Yes
ANTI-CYCLING	Anti-Cycling Time	23	No	No	Yes	Yes
	Anti-Cycling Override Differential	23	No	No	Yes	Yes
	Ramp Delay	23	No	No	Yes	Yes
	Ramp Settings	24	No	No	Yes	Yes
CONTROL MODES	Controlling Sensor	24	No	No	Yes	Yes
	BMS Tstat Input	24	No	No	Yes	Yes
	BMS	24	No	No	Yes	Yes
	ModBus	24	No	No	Yes	Yes
	ModBus T/O	24	No	No	Yes	Yes
	Cascade Address	24	No	No	Yes	Yes
	Cascade Type	24	No	No	Yes	Yes
	Max Cascade Set Point	25	No	No	Yes	Yes
	Cascade Offset	25	No	No	Yes	Yes
	Cascade Differential	25	No	No	Yes	Yes
	Min On/Off Time	25	No	No	Yes	Yes
	Min Next On Time	25	No	No	Yes	Yes
	Boiler Size	25	No	No	Yes	Yes
CIRCULATION PUMPS	System Pump Delay	25	No	No	Yes	Yes
	Boiler Pump Delay	26	No	No	Yes	Yes
	DHW Pump Delay	26	No	No	Yes	Yes
	Boiler Pump Anti-Seize Delay	26	No	No	Yes	Yes
	Boiler Pump Min Voltage	26	No	No	Yes	Yes
	System Pump Type	26	No	No	Yes	Yes
	DHW Blocks Sys Pump	26	No	No	Yes	Yes
	DHW Forces Sys Pump	26	No	No	Yes	Yes
	DHW Pump Anti-Seize Delay	26	No	No	Yes	Yes
	System Pump Anti-Seize Delay	26	No	No	Yes	Yes

# 1 Service

## Parameter table

**Table 1-4** (continued from previous page) This table lists SMART SYSTEM control module parameters and where to access them

Menu	Description	See Page	User Access		Installer Access	
			Display	Modify	Display	Modify
BMS	BMS Type	26	No	No	Yes	Yes
	Volts at Min	26	No	No	Yes	Yes
	Volts at Max	26	No	No	Yes	Yes
	Rate at Min Volts	26	No	No	Yes	Yes
	Rate at Max Volts	26	No	No	Yes	Yes
	Set Point at Min Volts	27	No	No	Yes	Yes
	Set Point at Max Volts	27	No	No	Yes	Yes
	On Volts	27	No	No	Yes	Yes
	Off Differential Volts	27	No	No	Yes	Yes
SERVICE NOTIFICATION	Service Notification Months	27	No	No	Yes	Yes
	Service Notification Running Time	27	No	No	Yes	Yes
	Service Notification Cycles	27	No	No	Yes	Yes
	Reset Maintenance Reminder	27	No	No	Yes	Yes
	Service Name and Phone Number	27	No	No	Yes	Yes

# 1 Service *(continued)*

## Viewable and changeable control parameters

### CAUTION

Before changing parameters, note the settings so that the unit can be returned to its original operating parameters.

### General

#### Time and Date

The control uses an internal clock for the night setback feature and for logging of events. For these features to work correctly, the clock must be set when the boiler is first installed or anytime the boiler has been powered off for more than four (4) hours. This parameter must be accessed to set the clock.

### NOTICE

The internal clock does not adjust for Daylight Savings Time and therefore, will require a manual adjustment.

The clock is automatically updated whenever a PC is connected and the Win\_Pro-Installer program is started.

#### Software Version

The software version allows the user to view the software version in use by the control. This software controls the operation of the boiler. When a new software version becomes available, the existing control can be replaced with a new control to update the software.

Software version is read only.

#### Temperature units (°C / °F)

The control can be configured to display temperature in either °C or °F. This parameter can be changed by the user or the installer by accessing the *Temperature Units* parameter. The default is °F.

#### Space Heating (SH) and Domestic Hot Water (DHW) Night Setback Offset

Once the unit's internal clock has been set correctly, the Night Setback feature can be used to program a lower set point during unoccupied times. Both the space heating and DHW can be programmed for night setback. When in night setback, the control reduces the set point by a fixed amount. For space heating, it subtracts the space heating night setback offset from each of the SH user set points (*SH1*, 2, and 3 *Set point* parameters), or the calculated outdoor reset set point (if lower). For DHW, it subtracts the DHW night setback offset from the tank set point (*Tank Set point* parameter).

**NOTE:** The DHW night setback will not work without a tank sensor installed.

The installer may adjust the space heating night setback offset by accessing the *SH Night Setback Offset* parameter and the DHW night setback offset by accessing the *DHW Night Setback Offset* parameter. The minimum setting is 0°F (0°C) and the maximum setting is 90°F (50°C).

#### Space Heating (SH) and Domestic Hot Water (DHW) Night Setback On Times

This is the time in which the SH Night Setback Offset becomes active. There are 7 start times and 7 stop times each for the space heating and DHW night setback features. Both may be set to any time within a 7-day week. These settings are referred to as triggers. Multiple start or stop triggers may be set within a single day, if desired. When a start trigger and a stop trigger are set to the same time, the stop trigger has priority. The installer may adjust the space heating night setback start triggers by accessing the *SH Night Setback On Times* parameter. The DHW start triggers in the *DHW Night Setback On Times* parameter. This screen shows the start trigger number, the day of the week, and the time of day.

### NOTICE

Please note that the brackets ([]) denote screen status.

1. When the screen is first accessed, start trigger number 1 is shown. If a different trigger number is desired, the installer can rotate the NAVIGATION dial until the desired trigger number is displayed. Once the desired trigger number is selected, the installer can press the NAVIGATION dial and the day of the week will start to flash.
2. The installer can adjust the day of the week to the one he wishes to set. Once the day is set, the installer can press the NAVIGATION dial and the hour will begin to flash.
3. After setting the hour, the installer can press the NAVIGATION dial and the minutes will flash. Once all settings have been made, the installer can press the RIGHT SELECT [SAVE] key. The installer can now select a different trigger and adjust the settings for that trigger.
4. Once all adjustments are made, the installer can press the RIGHT SELECT [SAVE] key to save all of the new settings and return to the **General** menu, or press the LEFT SELECT [EXIT] key to return to the **General** menu without saving the changes.

#### Space Heating (SH) and Domestic Hot Water (DHW) Night Setback Off Times

The corresponding space heating night setback stop triggers are set by accessing the *SH Night Setback Off Times* parameter. The stop triggers for the DHW night setback feature can be adjusted by accessing the *DHW Night Setback Off Times* parameter. The adjustment procedure for these parameters is identical to the space heating start triggers described above.

#### Night Setback Override

Any Night Setback On trigger currently active or scheduled within the next seven (7) days can be skipped. To skip a trigger, rotate the NAVIGATION dial until the arrow (>) is next to the trigger you wish to skip. Press the NAVIGATION dial once. "SK" will appear next to that trigger to indicate that it will be skipped. You can restore an upcoming trigger by selecting that trigger, and pressing the NAVIGATION dial again. The "SK" next to that trigger will disappear.

# 1 Service

To save any changes and return to the Home Screen, press the RIGHT SELECT [HOME] key. To return to the Status Screen without saving the changes, press the LEFT SELECT [EXIT] key.

## Display Timeout

This is the time in which the display remains illuminated. The range is 10 seconds to 10 minutes. The default is 3 minutes.

## Temperature Settings

### CAUTION

Mixing valves are required for the protection of any low temperature loops.

Space heating (SH) set point parameters limit boiler operating set point. The exact boiler operating set point is calculated using the outdoor reset curve. Outdoor reset is a feature that increases the temperature setting of the boiler as outdoor temperatures drop and decreases boiler set point as outdoor temperatures rise. The outdoor reset parameters can be accessed through the *Outdoor Reset* menu.

## Space Heating (SH1, SH2, SH3) Set Point

There are three (3) individual space heating set points. These are listed as *SH1 Set Point* through *SH3 Set Point*. These set points provide an upper limit to the outdoor reset curve for each zone. If multiple space heating set points are calling for heat, the highest set point has priority. If the outdoor sensor is not functioning, the boiler will operate at *SH Set Point* and the display screen will indicate "Outdoor Sensor Fault". The range of this parameter is *SH Minimum Set Point* to *SH Maximum Set Point*. The default is 125°F (52°C).

## Space Heating (SH) Minimum Set Point

The *SH Minimum Set Point* sets the minimum water temperature set point allowed for *SH Set Point (1 - 3)* adjustment. The user or installer will not be able to program the control with a lower SH set point. This parameter can only be changed by the installer by accessing the *Minimum SH Set Point* parameter. The temperature range is 32°F (0°C) to the space heating maximum set point. The default value is 32°F.

## Space Heating (SH) Maximum Set Point

The *SH Maximum Set Point* sets the maximum water temperature set point that can be used for space heating. The user or installer will not be able to program the control with a higher SH set point. This parameter can only be changed by the installer by accessing the *Maximum SH Set Point* parameter. The temperature range of this parameter is the space heating minimum set point to 180°F (82°C). The default value is 180°F.

## SH1 - SH3 Offset Set Point

The *SH Offset* sets how many degrees above set point the temperature has to go before the boiler will shut off. This parameter can only be changed by the installer by accessing *SH1, 2 and 3 Offset Set Point* parameters. The temperature range of these parameters is 0°F to 20°F. The default value is 10°F.

## SH1 - SH3 Differential Set Point

The *SH Differential* sets how many degrees below the offset the temperature has to drop before the boiler turns back on. This parameter can only be changed by the installer by accessing the *SH1, 2 and 3 Differential Set Point* parameters. The range is 0°F to 60°F. The default is 20°F.

## 3-Way Valve Time

The optional Lochinvar Multi-Temperature Loop Control Board (MTLCB) can be used to control the supply temperature up to three (3) sub-loops, corresponding to each of the three (3) SH set points, through the use of 3-way mixing valves. To ensure the MTLCB will control these temperature properly, it is necessary to let the control know how much time these mixing valves require to fully open and close. Program this time into the *3-Way Valve Time* parameter. Since this parameter applies to all of the mixing valves used, the actual open/close time must be approximately the same for each one. The minimum setting is 1 second, and the maximum setting is 255 seconds. The default setting is 20 seconds.

## Data Logging

### Reset log errors

The reset log errors function clears the last 10 errors log.

## Functions

### Service Mode Delay

By pressing the pin button on the front of the display for five (5) seconds, the control will be placed in Service Mode. This will override all other heat demands. The Service Mode allows the installer to set the unit to any firing rate for the purpose of combustion analysis. The delay sets the length of time the boiler will stay in the Service Mode if no keys have been pressed before going back to its original state. This parameter can only be changed by the installer by accessing the *Service Mode Delay* parameter. The time range of this parameter is 1 to 10 minutes. The default value is 10 minutes.

### Freeze Protection Pump On

The SMART SYSTEM control will turn on the boiler and system pump outputs whenever the inlet temperature drops below this setting. This is done to prevent the water in the heat exchanger from freezing. Certain low-temperature applications (such as snow melt) can operate at temperatures around freezing, so this setting needs to be lowered in these cases. The installer can adjust the temperature at which the pump outputs are turned on by accessing *Freeze Protection Pump On* parameter. The minimum setting is -3°F (-19°C), and the maximum setting is 45°F (7.2°C). The default setting is 45°F (7.2°C).

### NOTICE

Never put the Freeze Protection Pump on a setting lower than the Freeze Protection Burner On setting.

# 1 Service *(continued)*

## Freeze Protection Burner On

If running the pumps does not prevent the inlet temperature from falling closer to freezing, the SMART SYSTEM control will fire the burner at low fire. The installer can adjust the temperature at which the burner fires by adjusting the *Freeze Protection Burner On* parameter. The minimum setting is -3°F (-19°C), and the maximum setting is 45°F (7.2°C). The default setting is 37°F (2.8°C).

## Freeze Protection Burner Differential

Once the burner has started firing due to a low inlet temperature, the inlet temperature must increase by this amount before the burner turns back off. The installer can adjust this differential by accessing the *Freeze Protection Burner Differential* parameter. The minimum setting is 0°F, and the maximum is 20°F. The default setting is 5°F (2.8°C).

## DHW Settings

### DHW Boiler Set Point

When a DHW call for heat becomes active, the control will use the DHW boiler set point to determine the firing rate of the boiler based on the boiler outlet water temperature, or system temperature when DHW is programmed as a zone.

This parameter can be changed by the installer by accessing the *DHW Boiler Set point* parameter. The temperature range of this parameter is 68°F (20°C) to 180°F (82°C). The default value is 180°F (82°C).

### DHW Tank Set Point

By installing a tank sensor, the SMART SYSTEM control can perform the tank thermostat function. The SMART SYSTEM control automatically detects the presence of this sensor, and generates a DHW call for heat when the tank temperature drops below the tank set point differential (*Tank Set point Differential* parameter), and finishes the call for heat when the tank temperature reaches tank set point. This parameter can be changed by the installer by accessing the *DHW Tank Set point* parameter. The temperature range of this parameter tank minimum set point to tank maximum set point. The default value is 125°F (52°C).

### Tank Set Point Differential

When a tank sensor is installed, the tank temperature must drop this amount below the tank set point (*DHW Tank Set point* parameter) before the boiler turns back on. The installer can adjust this setting by accessing the *Tank Set point Differential* parameter. The minimum setting is 0° (0°C), and the maximum is 40°F (22°C). The default setting is 6°F (3°C).

### DHW Boiler Offset

This parameter reflects the degrees above DHW boiler set point the temperature has to go before the boiler will shut off. The range is 0°F (0°C) to 40°F (22°C). The default setting is 10°F (6°C).

### DHW Boiler Differential

This parameter reflects the degrees below DHW boiler set point the temperature has to go before the boiler turns back on. The range is 0°F (0°C) to 60°F (33°C). The default setting is 20°F (13°C).

## SH/DHW Switching Time

When a boiler has a space heating demand and it receives a DHW demand, it will immediately switch to the DHW demand and start a timer. Once the timer has expired, the boiler will switch back to the space heating demand and start another timer.

Once this timer expires, it will switch back to the DHW demand. The installer can adjust the length of time the boiler will service the space heating demand by accessing *SH/DHW Switching Time* parameter. The minimum setting is 0 minutes and the maximum setting is 50 minutes. The default time is 30 minutes.

## DHW/SH Switching Time

When a boiler has a DHW demand and it receives a space heating demand, the SMART SYSTEM control will start a timer. Once the timer expires, it will stop the DHW demand and service the space heating demand. The installer can adjust the length of time the boiler will service the DHW demand by accessing the *DHW/SW Switching Time* parameter. The minimum setting is 0 minutes and the maximum setting is 50 minutes. The default setting is 30 minutes.

## Tank Minimum Set Point

This setting controls the minimum tank set point for the tank temperature. The installer can adjust this by accessing the *Tank Minimum Set point* parameter. The minimum setting is 60°F (16°C) and the maximum setting is the maximum tank set point (*Tank Maximum Set point* parameter). The default value is 60° (16°C).

## Tank Maximum Set Point

This setting controls the maximum tank set point for the tank temperature. The installer can adjust this by accessing the *Tank Maximum Set point* parameter. The minimum setting is the minimum tank set point (*Tank Minimum Set point* parameter) and the maximum setting is 190°F (88°C). The default value is 140°F (60°C).

## DHW Type

This parameter determines whether the Knight boiler treats the indirect DHW tank as a separate load, or as a zone on the primary loop. When programmed as a separate load, the boiler will turn on the DHW pump and then turn off the boiler pump when an indirect DHW demand begins. When programmed as a zone, the boiler will turn on the DHW pump, leave the boiler pump on and change the system set point to the DHW boiler set point (*DHW Boiler Set point* parameter).

This setting may be changed by the installer by accessing the *DHW Type* parameter. The choices are NORMAL and ZONE. The default setting is NORMAL.

## Fan Speed Limiting for Indirect DHW Tank

This parameter determines the maximum fan speed (and therefore the maximum rate) to be used when heating an indirect DHW tank when the DHW Type is set to Normal. This setting may be used when the tank is unable to accept all of the BTU's available from the boiler. This parameter may be adjusted by the installer by accessing the *Fan Speed Limiting for Indirect DHW Tank* parameter. The default value is the maximum fan speed for that model.

# 1 Service

## Outdoor Reset

In accordance with the United States Energy Policy and Conservation Act, this boiler is equipped with outdoor reset, a feature that saves energy by reducing the boiler water temperature as the heating load decreases. In the absence of an external energy management system, outdoor reset **MUST BE** used. To use this feature, the outdoor sensor provided with the boiler must be properly installed. For better zone control, three (3) individual outdoor reset curves are available. If multiple zones are calling for heat, the highest set point has priority. Each curve is created using four (4) adjustable parameters: low outdoor air temperature, high outdoor air temperature, set point at low outdoor air temperature, and set point at high outdoor air temperature. The set point is calculated using the individual curve for each zone.

### Outdoor (1 - 3) Low

This parameter specifies the low outdoor air temperature. When the outdoor air temperature drops to this point, the zone set point will be at the *Set Point 1 at Low Outdoor Temp 1*, *Set Point 2 at Low Outdoor Temp 2* and *Set Point 3 at Low Outdoor Temp 3* parameters (FIG. 1-1). If the outdoor air temperature drops further below this setting, the set point will continue to increase. This parameter can be changed by the installer by accessing the *Outdoor (1-3) Low* parameters. The temperature range is -39°F (-39°C) to high outdoor air temperature set point. The default value is 25°F (-4°C).

### Outdoor (1 - 3) High

This parameter specifies the high outdoor air temperature. When the outdoor air temperature rises to or above this point, the water temperature set point will be at *Set point (1 - 3) at High Outdoor Temp (1 - 3)* parameters (FIG. 1-1).

This parameter can be changed by the installer by accessing the *Outdoor (1-3) High* parameters. The temperature range is low outdoor air temperature set point to 104°F (40°C). The default value is 70°F (21°C).

### Set Point (1 - 3) at Low Outdoor Temperature

When the outdoor air temperature drops to the *Outdoor (1 - 3) Low* parameter, the set point will be at this setting (FIG. 1-1). However, the outdoor reset curve is limited by the *SH (1 - 3) Set Points*. If *SH1*, *SH2*, and *SH3* are set lower, the water temperature will be at these set points instead. If the outdoor air temperature continues to drop below the *Outdoor (1 - 3) Low* parameter, the set point will continue to increase above this setting until *SH1 (1 - 3) Set Point* is met. These parameters can be changed by the installer by accessing the *Set point 1 at Low Outdoor Temp 1*, *Set point 2 at Low Outdoor Temp 2* and *Set point 3 at Low Outdoor Temp 3* parameters. The temperature range of this parameter is 68°F (20°C) to 180°F (82°C). The default value is 180°C (82°C).

### Set Point (1 - 3) at High Outdoor Temperature

When the outdoor air temperature rises to or above the *Outdoor (1 - 3) High* parameter, the calculated set point will be at this setting (FIG. 1-1). These parameters can be changed by the installer by accessing the *Set point 1 at High Outdoor Temp 1*, *Set point 2 at High Outdoor Temp 2* and *Set point 3 at High Outdoor Temp 3* parameters. The temperature range of this parameter is 68°F (20°C) to 190°F (88°C). The default value is 70°F (21°C).

### Outdoor Air Shutdown (SH1 - SH3)

The *Outdoor Air Shutdown* parameter specifies the outdoor air temperature at which there is no longer space heating demand. When the outdoor temperature rises above this point, the control will block all SH demands (DHW demands will still be active). These parameters can be changed by the installer by accessing the *Outdoor Air Shutdown SH1*, *SH2*, and *SH3* parameters. The temperature range of this parameter is 32°F (0°C) to 104°F (40°C). The default value is 70°F (21°C).

Figure 1-1 Outdoor Air Reset Curve

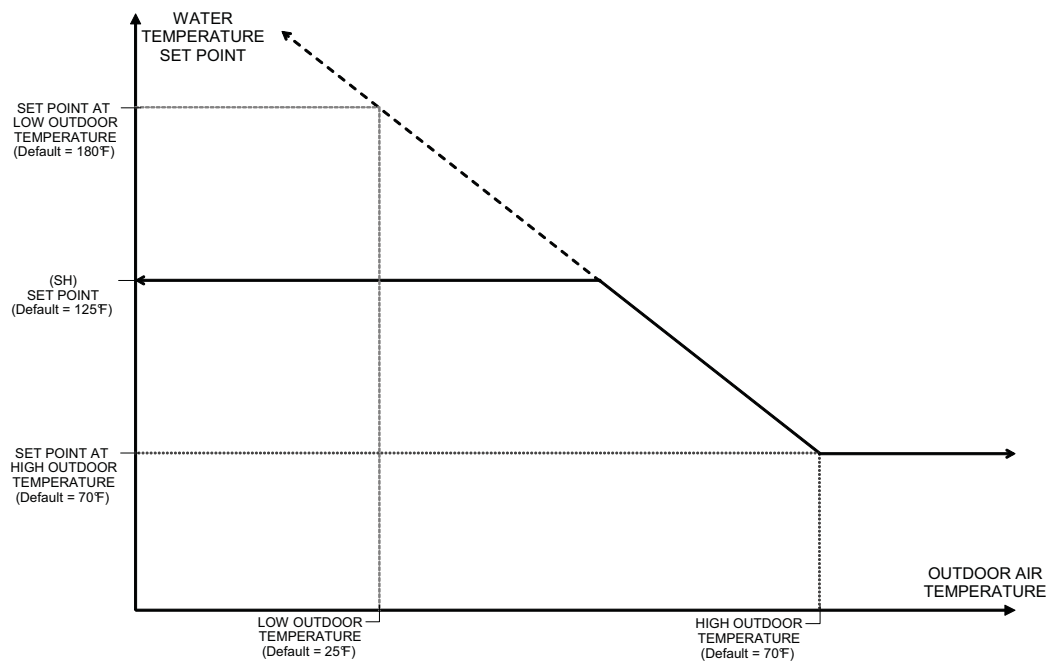

# 1 Service *(continued)*

## Outdoor Air Shutdown Differential (SH1 - SH3)

The outdoor air shutdown differential parameter is the number of degrees below *Outdoor Air Shutdown SH1, SH2, and SH3 parameters* the outdoor air temperature must go before the boiler will respond to a SH demand. These parameters can be changed by the installer by accessing the *Outdoor Air Shutdown Differential SH1, SH2, and SH3 parameters*. The temperature range of this parameter is 0°F (0°C) to 54°F (30°C). The default value is 10°F (6°C).

## Shift Reset Curve (SH1 - SH3)

There is a shift reset curve for each outdoor reset. The shift reset curve parameter shifts the actual set point above or below the calculated set point by the number of degrees in this parameter. These parameters can be changed by the installer by accessing the *Shift Reset Curve SH1, SH2, and SH3 parameters*. The temperature range of this parameter is -17°F (-10°C) to 18°F (10°C). The default value is 0°F (0°C). This feature will be active if this parameter is set to anything other than 0°F (0°C).

## Boost Temperature

If a SH demand lasts longer than the programmed time delay setting and there have been no DHW demands, the control will increase the water temperature set point by the amount in this parameter. If the SH demand continues through another time period, the set point will be increased again. This will continue until either the SH demand ends, a maximum of 20 increases has occurred, or SH1, SH2, SH3 maximum set point has been reached. Once the SH demand has been satisfied the set point will revert back to its calculated setting. The boost temperature can be changed by the installer by accessing the *Boost Temperature parameter*. The temperature range of this parameter is 0°F (0°C) to 25°F (14°C). The default value is 0°F (0°C). This feature will be active if this parameter is set to anything other than 0°F (0°C).

## Boost Time

The boost time parameter sets the amount of time that must elapse with a SH demand before the water temperature calculated set point will be increased. This parameter can be changed by the installer by accessing the *Boost Time parameter*. The time range for this parameter is 0 minute to 50 minutes. The default value is 0 minutes.

## Anti-Cycling

### Anti-Cycling Time

Once a SH demand has been satisfied, a set amount of time must elapse before the control will respond to a new SH demand. The control will block the new heat demand and anti-cycling will be shown in the display until the time has elapsed or the water temperature drops below the *Anti-Cycling Override Differential parameter*. This parameter can be changed by the installer by accessing the *Anti-Cycling Time parameter*. The time range for this parameter is 1 minute to 10 minutes. The default value is 1 minute.

### Anti-Cycling Override Differential

The control will bypass the anti-cycling time if the inlet water temperature drops too much. The control will use the inlet water temperature the boiler was at when it shut off as the starting point. If the inlet temperature drops below the temperature parameter the control will abort anti-cycling and allow the boiler to fire. This parameter can be changed by the installer by accessing the *Anti-Cycling Override Differential parameter*. The temperature range of this parameter is 0°F (0°C) to 54°F (30°C). The default value is 10°F (6°C).

### Ramp Delay (Enable / Disable)

This parameter allows the installer to enable or disable the SH ramp delay. The default setting is disabled.

**Figure 1-2 Ramp Delay Interval**

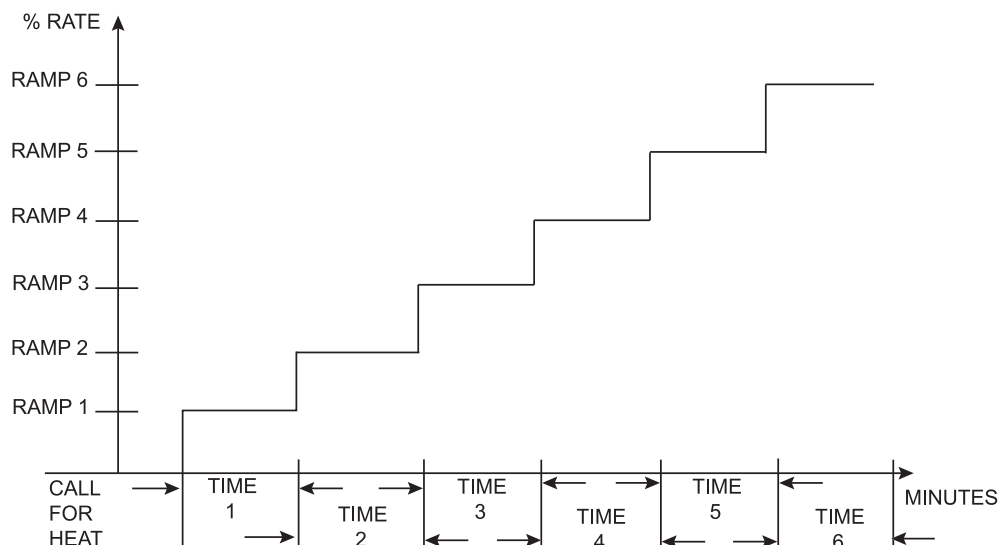

# 1 Service

## Ramp Settings

### NOTICE

Please note that the brackets ([ ]) denote screen status.

The SMART SYSTEM control can be programmed to limit the firing rate for a fixed period of time at the start of a space heating demand. There are six (6) possible limits, each with their own time delay. The first limit applies as soon as the burner starts. Once its time delay expires, the second limit is applied and its timer begins. The control steps through these limits until the 6th (sixth) limit expires. Note, however, that the 6th limit will also limit the rate for the rest of that heat demand. The installer can adjust the firing limits and time delays by accessing the *Ramp Settings parameter*. Once this parameter is selected, the screen will show the step number, the time delay for that step and the limit value corresponding with that step. If the installer wishes to adjust one of the values in that step, he can press the NAVIGATION dial until the value he wishes to change is flashing. The installer can then rotate the NAVIGATION dial to adjust that value. If the installer presses the RIGHT SELECT [SAVE] key while the limit value is flashing, the step value will flash again. The installer can then select the next step and adjust the delay and limit values corresponding with that step.

When finished, the installer can press the RIGHT SELECT [SAVE] key to store the new settings, or the LEFT SELECT [EXIT] key to return to the *Anti-Cycling* parameter list without saving the changes. The delay value can be set between 0 minutes and 20 minutes. The limit value can be set between 0% and 100%.

## Control modes

The United States Energy Policy and Conservation Act requires residential heating boilers with inputs less than 300,000 Btu/hr be equipped with a control that automatically adjusts boiler water temperature in relation to heat demand. An external control may be connected to control the firing rate or the set point of the boiler provided that either an external energy management system is installed that reduces the boiler water temperature as the heating load decreases, the boiler is not used for any space heating, or the boiler is part of a modular or multiple boiler system having a total input of 300,000 Btu/hr or greater.

## Controlling Sensor

The SH controlling sensor parameter selects the sensor the control will use to regulate the boiler firing rate. This parameter is adjustable by the installer by accessing the *Controlling Sensor* parameter. The sensor selections are as follows: The outlet sensor regulates the firing rate based on the outlet water temperature of the boiler and the inlet sensor regulates the firing rate based on the inlet water temperature of the boiler. The inlet temperature control is only available with a stand-alone boiler. If the outlet sensor is selected, and the optional system supply sensor is connected, the control will regulate the firing rate based on the system supply sensor temperature. The default sensor is the Outlet Sensor.

## BMS Thermostat Input

When controlling the boiler through the 0 - 10V BMS input or through ModBus, the boiler can be enabled one of two ways. With the *BMS Thermostat Input* parameter set to ACTIVE, the boiler will be enabled by closing the Heat/Loop Demand 1 input. When set to INACTIVE, the boiler will be enabled by the voltage level on the 0 - 10V input (in the case of 0 - 10V BMS control), or the 0 - 10V input value received through ModBus. The default value is INACTIVE.

## BMS

The set point or modulation of the boiler may be controlled through the 0 - 10V BMS input or through ModBus. When the *BMS* parameter is set to INACTIVE, the 0 - 10V input will be ignored. When set to ACTIVE, the set point or modulation will be controlled by the voltage on the 0 - 10V input (in the case of 0 - 10V BMS control), or the 0 - 10V input value received through ModBus. The default value is INACTIVE.

## ModBus

When BMS is set to ACTIVE (see BMS Active / Inactive) and the boiler is being controlled through ModBus, set *ModBus* parameter to ACTIVE. Otherwise, set the *ModBus* parameter to INACTIVE. Note that the boiler can still be monitored by ModBus with this parameter set to INACTIVE. The default value is INACTIVE.

## ModBus T/O

The amount of time the unit controls will wait to receive a communication string from the BMS controller before reverting back to its own internal parameters. This parameter is adjustable by the installer by accessing the *ModBus T/O* parameter. The adjustment range of this parameter is 5 seconds to 2 minutes. The default value is 10 seconds.

## Cascade Address

The boiler designated as the Leader needs to be programmed with address 0. All the Member boilers require addresses from 1 to 7, and the addresses must be different for each Member. The addresses can be in any order, regardless of the order in which the units are wired together. This parameter is adjustable by the installer by accessing the *Cascade Address* parameter. The outdoor air (if used) and system supply sensor must be connected to the Leader boiler. The default address is 1.

## Cascade Type (L/L / EFF)

There are two (2) options for the way a Cascade divides the load between its heaters. The first is Lead/Lag, designated as L/L in the menu. This method is used when it is desired to have the least amount of total flow through the boilers. This method will modulate the last two (2) boilers. This provides for smooth transitions when a boiler turns on or off. When the last boiler reaches 100% and the calculated load is still increasing, it will start the next boiler at 20% and reduce the previous boiler to 80%, thus eliminating the sudden jump in total output of the Cascade. When the calculated load is decreasing and the last boiler gets down to 20% fire, it will hold it there and start lowering the firing rate on the next-to-last boiler. When the next-to-last boiler reaches 20%, it will turn the last boiler off and raise the rate of the next-to-last boiler to 40%, thus eliminating the sudden drop in total output of the Cascade.



# 1 Service *(continued)*

The other Cascade divider method is Efficiency Optimization, designated as EFF in the menu. This method is used, as the name implies, when it is desired to have the most efficient system. When the first boiler reaches a certain rate (default = 90%), it lowers its rate to 45% and turns on the next boiler at 45%. The two (2) boilers then modulate at the same rate.

As the calculated load increases further and both boilers ramp up to 90%, it lowers the rate of the first two (2) boilers to 60% and brings the next boiler on at 60%. The three (3) boilers then modulate together. As the calculated load decreases, the boilers will reach a lower threshold (default = 30%), at which time the last boiler (the third in our example) will turn off and the Cascade will increase the rates of the remaining boilers to provide the equivalent total output as before ( $(3 \times 30\%) / 2 = 45\%$  in our example).

Efficiency optimization is automatically selected when boilers of different sizes are programmed into the Leader control (see *Boiler Size* on this page).

## Maximum Cascade Set Point

This parameter determines the set point used by the individual boilers in a Cascade when a system sensor is connected to the Leader boiler. When a boiler is commanded to fire by the Leader boiler, it will attempt to achieve this temperature at its outlet. The Leader boiler will limit the modulation of the last boiler to fire in order to hold the temperature at the system supply sensor to the user set point. If any of the boiler outlet temperatures reach the maximum cascade set point, the boiler will then modulate down on its own in order to keep its outlet temperature within the maximum cascade set point. Therefore, this parameter can be used to limit the outlet temperatures of all the boilers in a Cascade. Note that this parameter does not apply when the boiler is heating an indirect DHW tank. This parameter is adjustable by the installer by accessing the *Maximum Cascade Set Point* parameter. The temperature range of this parameter is 32° (0°C) to 190°F (88°C). The default maximum cascade set point is 185°F (85°C).

## Cascade Offset

This parameter determines how much the temperature must go above set point before the lead boiler will turn off. This parameter can be adjusted by the installer by accessing the *Cascade Offset* parameter. The temperature range of this parameter is 0° to 20°F (11°C). The default value is 10°F (6°C).

## Cascade Differential

This parameter determines how much the temperature must go below the turn off temperature (Set point + Offset) before the lead boiler turns on. This parameter can be adjusted by the installer by accessing the *Cascade Differential* parameter. The temperature range of this parameter is 0°F to 60°F (33°C). The default value is 20°F (11°C).

## Minimum On/Off Time

In order to prevent units in a Cascade from short cycling, this parameter defines the minimum ON and OFF time for each unit. The installer can adjust this time by accessing the *Minimum On/Off Time* parameter. The minimum setting is 0 seconds and the maximum setting is 10 minutes. The default is 30 seconds.

## Minimum Next On Time

In order to reduce the risk of temperature overshoot with a Cascade, this parameter defines the minimum time delay from starting one unit until the next unit may be started. The installer can adjust this time delay by accessing the *Minimum Next On Time* parameter. The minimum setting is 0 minutes and the maximum setting is 10 minutes. The default is 60 seconds.

## Boiler Size

When boilers of different sizes are connected together in a Cascade, the Leader boiler has to know the size of each boiler in that Cascade. The *Boiler Size* parameters allow the installer to program the size based on the Cascade address. This screen shows the Cascade address and the size of the boiler with that address (in BTU/hr):

1. When the Boiler Size screen is first accessed, Cascade Address 0 (Leader) is shown.
2. Press the NAVIGATION dial to access the first digit of the boiler size. Rotate the NAVIGATION dial to adjust the first digit. To access the next digit, press the NAVIGATION dial again. Continue this process until the correct boiler size (to the nearest 1000 BTU/hr) is shown. Press the RIGHT SELECT [SAVE] key.
3. Rotate the NAVIGATION dial to select the address of the next boiler in the Cascade. Repeat Step 2.
4. Once the size of the last boiler in the Cascade has been entered and saved, press the LEFT SELECT [EXIT] key to return to the Control Modes menu.
5. If no other parameters are to be adjusted, press the RIGHT SELECT [HOME] key to save the new settings and return to the Status screens.

The SMART SYSTEM control automatically uses the Efficiency Optimization Cascade type when controlling boilers of different sizes.

## Circulation pumps

### System Pump Delay

The system pump delay parameter sets the length of time the system pump (if connected) will run after a SH demand has been satisfied. This parameter is adjustable by the installer by accessing the *System Pump Delay* parameter. The time range for this parameter is 1 second to 40 minutes. The default time is 30 seconds.

# 1 Service

## Boiler Pump Delay

The SH pump delay parameter sets the length of time the boiler pump will run after a SH demand has been satisfied. Setting the delay time to 0 will disable the pump. This parameter is adjustable by the installer by accessing the *Boiler Pump Delay* parameter. The time range for this parameter is 1 second to 40 minutes. The default time is 30 seconds.

## DHW Pump Delay

The DHW pump delay parameter sets the length of time the DHW pump (if connected) will run after a DHW demand has been satisfied. This parameter is adjustable by the installer by accessing the *DHW Pump Delay* parameter. The time range for this parameter is 10 seconds to 40 minutes. The default time is 1 minute.

## Boiler Pump Anti-Seize Delay

If the boiler pump does not run for 24 hours, it will be turned on briefly to prevent it from seizing. The length of time it runs is determined by the *Boiler Pump Anti-Seize Delay* parameter. The range of this setting is 0 seconds to 50 minutes. The default setting is 20 seconds.

## Boiler Pump Minimum Voltage

The speed of the boiler pump can be controlled by the SMART SYSTEM control in order to maintain a minimum  $\Delta T$  through the heat exchanger. Thus, as the firing rate decreases, the speed of the boiler pump can decrease as well. The SMART SYSTEM control outputs a 0 - 10V signal to the boiler pump to control its speed. The *Boiler Pump Minimum Voltage* parameter determines the minimum voltage given to the boiler pump, thereby setting its minimum speed. The range of this setting is 2.5V to 10V. The default setting is 3.5V.

## System Pump Type

The system pump can be programmed to operate in response to any of the Room Thermostat inputs, or to run continuously until the boiler goes into Outdoor Shutdown. To program the system pump to operate only with a space heating call for heat, set the *System Pump Type* parameter to CFH. To program the system pump to run continuously until outdoor shutdown starts, set the *System Pump Type* parameter to WWSD. The default setting is CFH.

## DHW Forces Sys Pump

When the indirect DHW tank is connected as a zone on the primary loop, the *DHW Forces Sys Pump* parameter tells the system pump if it must run when there is a DHW demand. To have the system pump constantly running during a DHW demand, set the *DHW Forces Sys Pump* parameter to YES (the parameter *DHW Blocks Sys Pump* must be set to NO). If this parameter and the *DHW Blocks Sys Pump* parameter are both set to NO, the system pump operation will be based strictly on the *System Pump Type* parameter setting. The default setting of this parameter is YES.

## DHW Blocks Sys Pump

When the indirect DHW tank is connected as a zone on the primary loop, the *DHW Blocks Sys Pump* parameter tells the system pump if it is allowed to run during a DHW demand. To force the system pump to turn off during a DHW demand, set the *DHW Blocks Sys Pump* parameter to YES. The default setting is NO.

## DHW Pump Anti-Seize Delay

If the boiler pump does not run for 24 hours, it will be turned on briefly to prevent it from seizing. The length of time it runs is determined by the *DHW Pump Anti-Seize Delay* parameter. The range of this setting is 0 seconds to 50 minutes. The default setting is 20 seconds.

## System Pump Anti-Seize Delay

If the boiler pump does not run for 24 hours, it will be turned on briefly to prevent it from seizing. The length of time it runs is determined by the *System Pump Anti-Seize Delay* parameter. The range of this setting is 0 seconds to 50 minutes. The default setting is 20 seconds.

## BMS

### BMS Type

When programmed for BMS control through the 0 - 10V BMS input or through ModBus, the 0 - 10V signal can be interpreted as either a modulation command or a set point. When the *BMS Type* parameter is set to POWER, the 0 - 10V signal will control the modulation. When set to SETPOINT, the 0 - 10V signal will control the SH set point. The default setting is SETPOINT.

### Volts at Minimum

When programmed for BMS control through the 0 - 10V BMS input or through ModBus, the *Volts at Minimum* parameter should be set to the minimum voltage signal sent to the SMART SYSTEM control. The range of this parameter is 0.0V to the *Volts at Maximum* value. The default setting is 2.0V.

### Volts at Maximum

When programmed for BMS control through the 0 - 10V BMS input or through ModBus, the *Volts at Maximum* parameter should be set to the maximum voltage signal sent to the SMART SYSTEM control. The range of this parameter is the *Volts at Minimum* value to 10.0V. The default value is 10.0V.

### Rate at Minimum Volts

When programmed for BMS control through the 0 - 10V BMS input or through ModBus and the BMS Type is programmed as POWER, the modulation percentage represented by the *Volts at Minimum* parameter is set by the *Rate at Minimum Volts* parameter. The minimum value is 0% and the maximum is the Rate at Maximum Volts setting. The default value is 20%.

### Rate at Maximum Volts

When programmed for BMS control through the 0 - 10V BMS input or through ModBus and the BMS Type is programmed as POWER, the modulation percentage represented by the *Volts at Maximum* parameter is set by the *Rate at Maximum Volts* parameter. The minimum value is the *Rate at Minimum Volts* setting and the maximum is 100%. The default value is 100%.

# 1 Service *(continued)*

## Set Point at Minimum Volts

When programmed for BMS control through the 0 - 10V BMS input or through ModBus and the BMS Type is programmed as SETPOINT, the set point represented by the *Volts at Minimum* parameter is set by the *Set Point at Maximum Volts* parameter. The minimum value is 32°F (0°C) and the maximum is the *Set Point at Maximum Volts* setting. The default value is 70°F (21°C).

## Set Point at Maximum Volts

When programmed for BMS control through the 0 - 10V BMS input or through ModBus and the BMS Type is programmed as SETPOINT, the set point represented by the *Volts at Maximum* parameter is set by the *Set Point at Maximum Volts* parameter. The minimum value is the *Set Point at Minimum Volts* setting and the maximum is 190°F (88°C). The default value is 180°F (82°C).

## On Volts

When programmed for BMS control through the 0 - 10V BMS input or through ModBus and the BMS Thermostat Input is set to INACTIVE, the *On Volts* parameter determines the 0 - 10V BMS input voltage at which the boiler is enabled. The minimum value is 0.5V and the maximum is 10.0V. The default value is 2.0V.

## Off Differential Volts

When programmed for BMS control through the 0 - 10V BMS input or through ModBus and the BMS Thermostat Input is set to INACTIVE, the *Off Differential Volts* parameter determines how far below the *On Volts* setting the 0 - 10V BMS input voltage must be in order to disable the boiler. The minimum value is 0.2V and the maximum is the *On Volts* setting. The default value is 1.0V.

## Service Notification

### Service Notification in Months

When the boiler control determines that a scheduled service is due based on days of installation, the boiler display will alternate the standard boiler display text with the message SERVICE DUE every 5 seconds. This parameter is adjustable by the installer by accessing the *Service Notification in Months* parameter. The time range for this parameter is 0 months to 100 months. The default time is 12 months.

This feature has been disabled by the manufacturer. To enable this feature change parameter **K1** to the desired time range.

### Service Notification Running Time

When the boiler control determines that a scheduled service is due based on the hours of actual operation, the boiler display will turn yellow and a new status screen will appear informing the installer that maintenance is required. This parameter is adjustable by the installer by accessing the *Service Notification Running Time* parameter. The time range for this parameter is 0 hours to 17,500 hours. The default time is 8,760 hours.

## Service Notification Cycles

When the boiler control determines that a scheduled service is due based on the number of boiler cycles, the boiler display will alternate the standard boiler display text with the message SERVICE DUE every 5 seconds. This parameter is adjustable by the installer by accessing the *Service Notification Cycles* parameter. The range for this parameter is 0 cycles to 100,000 cycles. The default is 50,000 cycles.

## Reset Maintenance Reminder

Once servicing has been completed, the service notification counter should be reset. This parameter can be reset by the installer by accessing the *Reset Maintenance Reminder* parameter. Once accessed, press the RESET key to reset the service notification counter.

## Service Name and Phone Number

### NOTICE

Please note that the brackets ([]) denote screen status.

When a Maintenance Reminder timer or counter has expired, a Maintenance Reminder screen will appear on the display. By programming the installer's name and phone number, this information will appear on the Maintenance Reminder Screen at that time. This can be programmed by accessing the *Service Name and Phone Number* parameter. When selected, another menu will appear with PHONE and NAME.

1. Rotate the NAVIGATION dial to point to the name/phone number to program and press the NAVIGATION dial. The screen will now display the selected item (either PHONE or NAME).
2. Press the NAVIGATION dial again. A cursor will appear at the bottom of the screen. By rotating the NAVIGATION dial, various numbers and characters will appear. When the desired number/character is found, press the NAVIGATION dial. The cursor will move to the next position.
3. Repeat this procedure until the entire message is entered. If you make a mistake and wish to back up one character, rotate the NAVIGATION dial until the back arrow (←) character is displayed and press the NAVIGATION dial.
4. When finished, press the RIGHT SELECT [SAVE] key to return to the previous menu.

## 2 Maintenance

### Maintenance and annual startup

**Table 2-1** Service and Maintenance Schedules

Service technician (see the following pages for instructions)		Owner maintenance (see the Knight User's Information Manual for instructions)	
<b>ANNUAL START-UP</b>	<b>General:</b>		<b>Daily</b>
	<ul style="list-style-type: none"> <li>• Address reported problems</li> <li>• Inspect interior; clean and vacuum if necessary;</li> <li>• Clean condensate trap and fill with fresh water</li> <li>• Check for leaks (water, gas, flue, condensate)</li> <li>• Verify flue and air lines in good condition and sealed tight</li> <li>• Check system water pressure/system piping/expansion tank</li> <li>• Check control settings</li> <li>• Check ignition and flame sense electrodes (sand off any deposits; clean and reposition)</li> <li>• Check wiring and connections</li> <li>• Perform start-up checkout and performance verification per Section 10 in the Knight Installation and Operation Manual.</li> <li>• Flame inspection (stable, uniform)</li> <li>• Flame signal (at least 10 microamps at high fire)</li> <li>• Clean the heat exchanger if flue temperature is more than 54°F above return water temperature.</li> </ul>		<ul style="list-style-type: none"> <li>• Check boiler area</li> <li>• Check pressure/temperature gauge</li> </ul>
	<b>If combustion or performance indicate need:</b>		<b>Monthly</b>
	<ul style="list-style-type: none"> <li>• Clean heat exchanger</li> <li>• Remove and clean burner using compressed air only</li> <li>• Clean the blower wheel</li> </ul>		<ul style="list-style-type: none"> <li>• Check vent piping</li> <li>• Check air piping</li> <li>• Check air and vent termination screens</li> <li>• Check relief valve</li> <li>• Check condensate drain system</li> <li>• Check air vents</li> </ul>
			<b>Periodically</b>
		<b>Every 6 months</b>	
		<b>End of season months</b>	
			<ul style="list-style-type: none"> <li>• Test low water cutoff (if used)</li> <li>• Reset button (low water cutoff)</li> <li>• Check boiler piping (gas and water) for leaks</li> <li>• Operate relief valve</li> <li>• Shut boiler down (unless boiler used for domestic hot water)</li> </ul>

## 2 Maintenance *(continued)*

### ⚠ WARNING

Follow the Service and maintenance procedures given throughout this manual and in component literature shipped with the boiler. Failure to perform the service and maintenance could result in damage to the boiler or system. Failure to follow the directions in this manual and component literature could result in severe personal injury, death, or substantial property damage.

### ⚠ WARNING

The boiler should be inspected annually only by a qualified service technician. In addition, the maintenance and care of the boiler designated in Table 2-1 and explained on the following pages must be performed to assure maximum boiler efficiency and reliability. Failure to service and maintain the boiler and system could result in equipment failure.

### ⚠ WARNING

Electrical shock hazard – Turn off power to the boiler before any service operation on the boiler except as noted otherwise in this instruction manual. Failure to turn off electrical power could result in electrical shock, causing severe personal injury or death.

### Address reported problems

1. Inspect any problems reported by the owner and correct before proceeding.

### Inspect boiler area

1. Verify that boiler area is free of any combustible materials, gasoline and other flammable vapors and liquids.
2. Verify that air intake area is free of any of the contaminants listed in Section 1 of the Knight Boiler Installation and Operation Manual. If any of these are present in the boiler intake air vicinity, they must be removed. If they cannot be removed, reinstall the air and vent lines per this manual and the Knight Boiler Installation and Operation Manual.

### Inspect boiler interior

1. Remove the front access cover and inspect the interior of the boiler.
2. Vacuum any sediment from inside the boiler and components. Remove any obstructions.

### Clean condensate trap

1. Inspect the condensate drain line, condensate PVC fittings, and condensate trap.
2. Remove the PVC cap retaining screw from the PVC cap (FIG. 2-1).
3. Remove the 2 inch PVC cap with the switch located at the top of the trap (FIG. 2-1).
4. Remove any sediment in the trap.
5. Fill with fresh water until the water begins to pour out of the drain.
6. Replace the cap. Press the cap onto the trap until the cap makes contact with the drain.
7. Replace the retaining screw.

**Figure 2-1** Condensate Trap

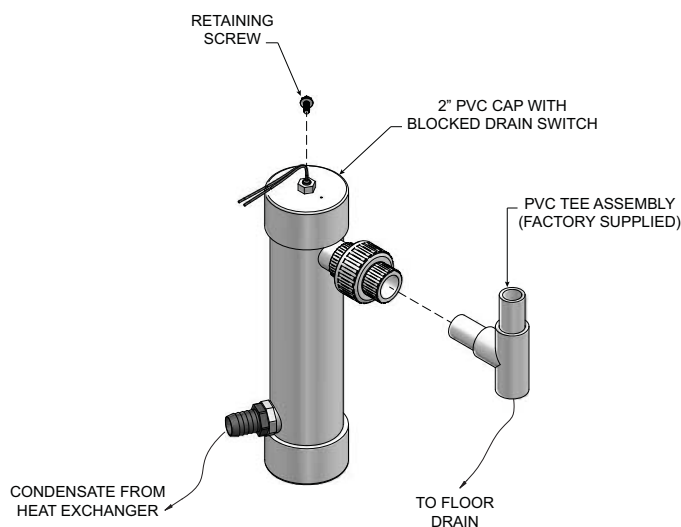

### ⚠ WARNING

The condensate trap must be filled with water during all times of boiler operation to avoid flue gas emission from the condensate drain line. Failure to fill the trap could result in severe personal injury or death.

### Check all piping for leaks

### ⚠ WARNING

Eliminate all system or boiler leaks. Continual fresh makeup water will reduce boiler life. Minerals can build up in sections, reducing heat transfer, overheating heat exchanger, and causing heat exchanger failure. Leaking water may also cause severe property damage.

1. Inspect all water and gas piping and verify to be leak free.
2. Look for signs of leaking lines and correct any problems found.
3. Check gas line using the procedure found in Section 7 - Gas Connections of the Knight Boiler Installation and Operation Manual.

## 2 Maintenance

### Flue vent system and air piping

1. Visually inspect the entire flue gas venting system and air piping for blockage, deterioration or leakage. Repair any joints that show signs of leakage. Verify that air inlet pipe is connected and properly sealed.
2. Verify that boiler vent discharge and air intake are clean and free of obstructions.

**⚠ WARNING** Failure to inspect for the above conditions and have them repaired can result in severe personal injury or death.

### Check water system

1. Verify all system components are correctly installed and operational.
2. Check the cold fill pressure for the system. Verify it is correct (must be a minimum of 12 psi).
3. Watch the system pressure as the boiler heats up (during testing) to ensure pressure does not rise too high. Excessive pressure rise indicates expansion tank sizing or performance problem.
4. Inspect automatic air vents and air separators. Remove air vent caps and briefly press push valve to flush vent. Replace caps. Make sure vents do not leak. Replace any leaking vents.

### Check expansion tank

1. Expansion tanks provide space for water to move in and out as the heating system water expands due to temperature increase or contracts as the water cools. Tanks may be open, closed or diaphragm or bladder type. See Section 6 - Hydronic Piping of the Knight Boiler Installation and Operation Manual for suggested best location of expansion tanks and air eliminators.

### Check boiler relief valve

1. Inspect the relief valve and lift the lever to verify flow. Before operating any relief valve, ensure that it is piped with its discharge in a safe area to avoid severe scald potential. Read Section 6 - Hydronic Piping of the Knight Boiler Installation and Operation Manual before proceeding further.

**⚠ WARNING** Safety relief valves should be re-inspected AT LEAST ONCE EVERY THREE YEARS, by a licensed plumbing contractor or authorized inspection agency, to ensure that the product has not been affected by corrosive water conditions and to ensure that the valve and discharge line have not been altered or tampered with illegally. Certain naturally occurring conditions may corrode the valve or its components over time, rendering the valve inoperative. Such conditions are not detectable unless the valve and its components are physically removed and inspected. This inspection must only be conducted by a plumbing contractor or authorized inspection agency – not by the owner. Failure to re-inspect the boiler relief valve as directed could result in unsafe pressure buildup, which can result in severe personal injury, death, or substantial property damage.

**⚠ WARNING** Following installation, the valve lever must be operated AT LEAST ONCE A YEAR to ensure that waterways are clear. Certain naturally occurring mineral deposits may adhere to the valve, rendering it inoperative. When manually operating the lever, water will discharge and precautions must be taken to avoid contact with hot water and to avoid water damage. Before operating lever, check to see that a discharge line is connected to this valve directing the flow of hot water from the valve to a proper place of disposal. Otherwise severe personal injury may result. If no water flows, valve is inoperative. Shut down the boiler until a new relief valve has been installed.

2. After following the above warning directions, if the relief valve weeps or will not seat properly, replace the relief valve. Ensure that the reason for relief valve weeping is the valve and not over-pressurization of the system due to expansion tank waterlogging or undersizing.

## 2 Maintenance *(continued)*

### Inspect ignition and flame sense electrodes

1. Remove the ignition and flame sense electrodes from the boiler heat exchanger access cover.
2. Remove any deposits accumulated on the ignition/flame sense electrode using sandpaper. If the electrodes cannot be cleaned satisfactorily, replace with new ones.
3. Replace ignition/flame sense electrode, making sure gasket is in good condition and correctly positioned.

### Check ignition ground wiring

1. Inspect boiler ground wire from the heat exchanger access cover to ground terminal strip.
2. Verify all wiring is in good condition and securely attached.
3. Check ground continuity of wiring using continuity meter.
4. Replace ground wires if ground continuity is not satisfactory.

### Check all boiler wiring

1. Inspect all boiler wiring, making sure wires are in good condition and securely attached.

### Check control settings

1. Set the SMART SYSTEM control module display to Parameter Mode and check all settings. See Section 1 of this manual. Adjust settings if necessary. See Section 1 of this manual for adjustment procedures.
2. Check settings of external limit controls (if any) and adjust if necessary.

### Perform start-up and checks

1. Start boiler and perform checks and tests specified in Section 10 - Start-up of the Knight Boiler Installation and Operation Manual.
2. Verify cold fill pressure is correct and that operating pressure does not go too high.

### Check burner flame

1. Inspect flame through observation window.
2. If the flame is unsatisfactory at either high fire or low fire, turn off boiler and allow boiler to cool down. Remove the burner and clean it thoroughly using a vacuum cleaner or compressed air. Do not use compressed air to clean burner if performed inside a building.
3. Remove the burner, reference FIG. 2-2 below.
4. When replacing the burner, ensure gasket is in good condition and positioned correctly (FIG. 2-2).

**Figure 2-2 Burner Assembly**

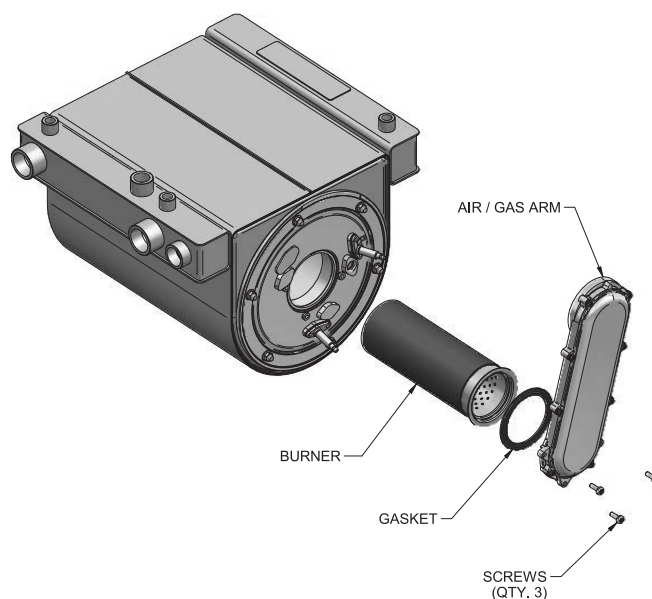

### Check flame signal

1. At high fire the flame signal shown on the display should be at least 10 microamps.
2. A lower flame signal may indicate a fouled or damaged flame sense electrode. If cleaning the flame sense electrode does not improve, ground wiring is in good condition, and ground continuity is satisfactory, replace the flame sense electrode.
3. See Section 3 - Troubleshooting in this manual for other procedures to deal with low flame signal.

## 2 Maintenance

### Review with owner

1. Review the Knight Boiler User's Information Manual with the owner.
2. Emphasize the need to perform the maintenance schedule specified in the Knight Boiler User's Information Manual (and in this manual as well).
3. Remind the owner of the need to call a licensed contractor should the boiler or system exhibit any unusual behavior.
4. Remind the owner to follow the proper shutdown procedure and to schedule an annual start-up at the beginning of the next heating season.

### Cleaning boiler heat exchanger

For recommended materials; including brush, appropriate extension(s), refractory cover, and detailed instructions see Table 2-2 - Heat Exchanger Cleaning Kits.

1. Shut down boiler:
  - Follow the "To Turn Off Gas to Appliance" instructions for the boiler in Section 10 - Startup of the Installation and Operation Manual.
  - Do not drain the boiler unless it will be exposed to freezing temperatures. If using freeze prevention fluid in system, do not drain.
2. Allow time for the boiler to cool to room temperature if it has been firing.
3. Remove the nuts securing the heat exchanger access cover to the heat exchanger and set aside.
4. Remove the heat exchanger access cover, burner, and gas/air arm assembly.

#### **⚠ WARNING**

The boiler contains ceramic fiber materials. Use care when handling these materials per the instructions on page 3 of this manual. Failure to comply could result in severe personal injury.

5. Remove the condensate hose from the heat exchanger end. Connect a field supplied 3/4" diameter hose to a drain pan. Using field supplied means, cover the refractory in the back of the combustion chamber of the heat exchanger.
6. Use a vacuum cleaner to remove any accumulation on the boiler heating surfaces. Do not use any solvent.
7. Brush the heat exchanger while dry using a nylon bristle brush. **Caution:** DO NOT use a metal brush. Re-vacuum the heat exchanger.
8. Finish cleaning using a clean cloth dampened with warm water. Rinse out debris with a low pressure water supply.

9. Allow the heat exchanger to thoroughly dry.
10. Remove the field supplied rear refractory cover from the back of the combustion chamber of the heat exchanger and reassemble.
11. Close isolation valves on piping to isolate boiler from system. Attach a hose to the boiler drain and flush boiler thoroughly with clean water by using purging valves to allow water to flow through the water make-up line to the boiler.
12. Perform start-up and check-out procedures in the Check Flame and Combustion - Section 10 - Startup of the Installation and Operation Manual.
13. Replace the access cover and restore boiler to operation.

**Table 2-2 Heat Exchanger Cleaning Kits**

Model	Kit Number	Part Number	Component Description
81 - 106	KIT30062	CTN20005	Rear Refractory Cover
		MSC20083*	Nylon 4" Wheel Brush*
		MSC20085	1/4" x 12" Drill Extension
151 - 286	KIT30063	CTN20005	Rear Refractory Cover
		MSC20083*	Nylon 4" Wheel Brush*
		MSC20084	3mm Allen Wrench
		MSC20086	1/4" x 24" Drill Extension

#### **⚠ CAUTION**

\* Do NOT use a metal brush. Only use the kit provided brush or an equivalent replacement nylon brush.

**Figure 2-3 Rope Gasket - Heat Exchanger Door**

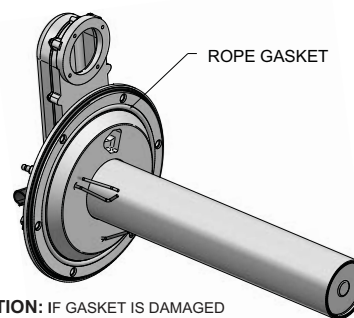

**CAUTION:** IF GASKET IS DAMAGED DO NOT REUSE, THE HEAT EXCHANGER DOOR MUST BE REPLACED.

#### **NOTICE**

Rope gasket is intended for sealing combustion (FIG. 2-3). If damaged DO NOT reuse, the heat exchanger door must be replaced. Consult factory for replacement heat exchanger door (kit WTR3080).

### Oiled bearing circulators

1. The circulator shipped with the Knight boiler is water-lubricated. No oiling is required.
2. Check other circulators in the system. Oil any circulators requiring oil, following circulator manufacturer's instructions. Over-oiling will damage the circulator.
3. Replace the boiler front access cover.



## 3 Troubleshooting

### ⚠ WARNING

Label all wires prior to disconnection when servicing controls. Wiring errors can cause improper and dangerous operation. Always disconnect power to the boiler before servicing. Failure to comply could result in severe personal injury, death, or substantial property damage.

### ⚠ WARNING

Never jumper (bypass) any device except for momentary testing as outlined in the Troubleshooting chart. Severe personal injury, death, or substantial property damage can result.

### Before troubleshooting:

- Have the following items:
  - Voltmeter that can check 120 vac, 24 vac, and 12 vdc.
  - Continuity checker.
  - Contact thermometer.
- Check for 120 vac (minimum 102 vac to maximum 132 vac) to boiler.
- Make sure thermostat is calling for heat and contacts (including appropriate zone controls) are closed. Check for 24 vac between thermostat wire nuts and ground.
- Make sure all external limit controls are installed and operating.

### Check the following:

- Wire connectors to control module are securely plugged in at the module and originating control.
- Gas pressures:
  - Maximum: 14 inches w.c. (natural and LP) with no flow (lockup) or with boiler on
  - Minimum: 4 inches w.c. (natural), 8 inches w.c. (LP) with gas flowing (verify during boiler startup)

### Check control module fuses

### NOTICE

ALWAYS check control module fuses before replacing control module or any major components (blower, etc.). If one of these fuses is blown, it can prevent the control module or other components from operating.

- Turn OFF the power to the boiler at the external line switch.
- Remove top access cover.
- Remove the control module cover.
- Inspect fuses F1, F2 and F3, see FIG 3-1 below.

**Figure 3-1 Control Module Fuses**

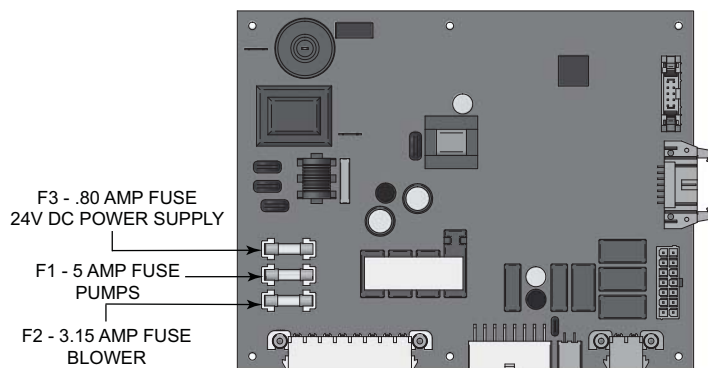

- The boiler is shipped with three (3) spare fuses in a plastic bag attached to the control module cover.
- If necessary, replace open fuse (F3 is .80 amps, F2 is 3.15 amps, and F1 is 5 amps).

**Note:** Fuses F1, F2 and F3 are all slow blow fuses.

### ⚠ WARNING

Do not jumper fuse or replace with any fuse except as specified. Failure to comply could result in severe personal injury, death, or substantial property damage.

- Install control module cover and top access cover after fuse inspection.
- Restore power to the boiler at the external line switch and verify boiler operation (Section 10 - Start-up in the Knight Boiler Installation and Operation Manual) after completing boiler service.

### 3 Troubleshooting

**Table 3-1 Troubleshooting Chart - No Display**

FAULT	CAUSE	CORRECTIVE ACTION
No Display	- No 120 vac supplied to unit.	<ul style="list-style-type: none"> <li>• Check external line switch, fuse, or breaker.</li> <li>• Check position of ON/OFF switch. Turn switch to the ON position.</li> <li>• Check 120 vac through the ON/OFF switch.</li> <li>• Check wiring harness connection between display board and main control board. Connect harness at both points.</li> </ul>
	- No voltage through the switch.	<ul style="list-style-type: none"> <li>• Replace switch.</li> </ul>
	- Bad display board.	<ul style="list-style-type: none"> <li>• Replace board.</li> </ul>
	- Bad main control board.	<ul style="list-style-type: none"> <li>• Replace the main control board.</li> </ul>
	- Blown fuse.	<ul style="list-style-type: none"> <li>• Replace fuse F3 on the main control board, see page 33 of this manual.</li> </ul>
No Burner Operation	- Main control board temperature set point satisfied.	<ul style="list-style-type: none"> <li>• Review temperature setting.</li> </ul>
	- Remote thermostat satisfied.	<ul style="list-style-type: none"> <li>• Review remote thermostat setting.</li> </ul>
	- Outside air temperature above Warm Weather Shutdown (WWSD) set point for main control board.	<ul style="list-style-type: none"> <li>• Check location of outside air sensor. Check resistance of outdoor air sensor and compare to Table 3-2B on page 35 of this manual.</li> </ul>
	- Unit locked out on fault.	<ul style="list-style-type: none"> <li>• Consult display for specific fault. Refer to fault descriptions on page 37 of this manual for corrective actions.</li> </ul>
	- Unit in Shutdown Mode.	<ul style="list-style-type: none"> <li>• Take unit out of Shutdown Mode.</li> </ul>
Unit Does Not Modulate Above 50%	- Ramp delay active.	<ul style="list-style-type: none"> <li>• Check ramp delay parameter settings. Optional PC software required.</li> </ul>
		<ul style="list-style-type: none"> <li>• Turn ramp delay feature off. See page 23 of this manual for instructions on how to turn this feature off.</li> </ul>
	- Boiler controlled by BMS.	<ul style="list-style-type: none"> <li>• Check BMS parameter settings. Optional PC software required.</li> </ul>
	- Flue sensor open.	<ul style="list-style-type: none"> <li>• Verify that the flue sensor is located in the flue outlet.</li> </ul>
		<ul style="list-style-type: none"> <li>• Check wiring connections at the flue sensor.</li> <li>• Check the resistance of the flue sensor and compare to Table 3-2D on page 35 of this manual.</li> </ul>

### 3 Troubleshooting *(continued)*

#### Checking temperature sensors

The boiler temperature sensors (inlet water, outlet water, system water, flue, and outdoor air) are all resistance type devices. The following tables show the correct values for the sensors at various temperatures. Use an ohmmeter to read the resistance of the sensor at a known temperature. If the resistance of the sensor does not closely match its corresponding table, replace the sensor.

It is important to note that the flue and outlet water sensors have two temperature sensing devices in one housing. These devices are designated as S1a/S1b, outlet sensor and S3a/S3b, flue sensor. Please reference the wiring diagram in the Knight Boiler Installation and Operation Manual for correct terminal location.

**Table 3-2A - Inlet Water/System Sensor Resistance vs. Temperature**

Temperature	Resistance	Temperature	Resistance
50	18,780	158	1,990
68	12,263	176	1,458
86	8,194	194	1,084
104	5,592	212	817
122	3,893		
140	2,760		

**Table 3-2B - Outdoor Air Sensor Resistance vs. Temperature**

Temperature	Resistance	Temperature	Resistance
-50	490,813	20	46,218
-40	336,606	30	34,558
-30	234,196	40	26,099
-20	165,180	50	19,900
10	118,018	60	15,311
0	85,362	70	11,883
10	62,465	80	9,299

**Table 3-2C - Outlet Water Sensor Resistance vs. Temperature**

S1a (Wire Color - R/BK and Y)				S1b (Wire Color - G and Y)			
Temperature	Resistance	Temperature	Resistance	Temperature	Resistance	Temperature	Resistance
50	19,553	158	2,004	50	40,030	158	3,478
68	12,690	176	1,464	68	25,030	176	2,492
86	8,406	194	1,084	86	16,090	194	1,816
104	5,715	212	816	104	10,610	212	1,344
122	3,958			122	7,166		
140	2,786			140	4,943		

**Table 3-2D - Flue Sensor Resistance vs. Temperature**

S3a (Wire Color - W/B and Y)				S3b (Wire Color - PR and Y)			
Temperature	Resistance	Temperature	Resistance	Temperature	Resistance	Temperature	Resistance
50	40,030	158	3,478	50	258,500	158	16,870
68	25,030	176	2,492	68	125,500	176	12,000
86	16,090	194	1,816	86	80,220	194	8,674
104	10,610	212	1,344	104	52,590	212	6,369
122	7,166			122	35,270		
140	4,943			140	24,160		

### 3 Troubleshooting

**Table 3-3 Troubleshooting Chart - Noisy System**

FAULT	CAUSE	CORRECTIVE ACTION
Noisy Operation	- Supply gas problem. Natural gas pressures should be between 4 inches w.c. and 14 inches w.c. LP gas pressures should be between 8 inches w.c. and 14 inches w.c.	<ul style="list-style-type: none"> <li>Refer to Section 7 - Gas Connections of the Knight Boiler Installation and Operation Manual for detailed information concerning the gas supply.</li> </ul>
	- Gas/air mixture problem.	<ul style="list-style-type: none"> <li>Refer to the Gas Valve Adjustment Procedure on page 47 of this manual for the proper gas valve setting. Verify that the vent/air intake lengths do not exceed the maximum listed in the General Venting section of the Knight Boiler Installation and Operation Manual.</li> </ul>
	- Dirty/damaged burner.	<ul style="list-style-type: none"> <li>Refer to page 31 in this manual for the burner removal and inspection procedure. Clean or replace the burner as necessary.</li> </ul>
	- Low water flow through the heat exchanger.	<ul style="list-style-type: none"> <li>Refer to Section 6 - Hydronic Piping of the Knight Boiler Installation and Operation Manual for minimum flow rates. Verify that the boiler is piped in a primary/secondary fashion and that the boiler and system pump are running on a call for heat.</li> </ul>
	- Air in the piping system.	<ul style="list-style-type: none"> <li>Properly purge all air from the piping system.</li> </ul>
	- Low system water pressure.	<ul style="list-style-type: none"> <li>Verify system pressure is a minimum of 12 psi.</li> </ul>
No Pump Operation - Boiler Pump System Pump or DHW Pump	- Blown fuse.	<ul style="list-style-type: none"> <li>Replace fuse F1 on the control board, see page 33 of this manual.</li> </ul> <p><b>Note:</b> Make sure pump amperage does not exceed 1.8 amps.</p>
	- Faulty pump.	<ul style="list-style-type: none"> <li>Replace pump.</li> </ul>
	- Internal fault on control board.	<ul style="list-style-type: none"> <li>Replace main control board.</li> </ul>
Relief Valve Opening	- System pressure exceeds relief valve setting.	<ul style="list-style-type: none"> <li>Lower the system pressure below the 30 psi rating of the supplied relief valve or replace the standard relief valve with a higher rated valve up to the maximum pressure of the heat exchanger.</li> <li>Improperly sized expansion tank.</li> </ul>

### 3 Troubleshooting *(continued)*

**Table 3-4 Troubleshooting Chart - Fault Messages Displayed on Boiler Interface**

FAULT	DESCRIPTION	CORRECTIVE ACTION
Gas Pressure SW (will require a manual reset once the condition has been corrected. Press the RESET button on the SMART SYSTEM display to reset.)	- Either the optional manual reset low gas pressure switch or the optional manual reset high gas pressure switch tripped.	<ul style="list-style-type: none"> <li>• Reset the pressure switches.</li> <li>• Measure the supply gas pressure to determine cause of failure. Natural gas pressures should be between 4 - 14 inches w.c. and LP gas pressures should be between 8 - 14 inches w.c.</li> <li>• Refer to Section 7 - Gas Connections of the Knight Boiler Installation and Operation Manual for detailed information concerning the gas supply.</li> <li>• Correct the supply gas pressure if necessary.</li> <li>• Check for a loose or misplaced jumper if pressure switches are not installed.</li> </ul>
	- The gas pressure switch contacts on the Low Voltage Connection Board are open.	<ul style="list-style-type: none"> <li>• Check for a loose or misplaced jumper on the Low Voltage Connection Board.</li> <li>• Check for the addition of a device wired across the gas pressure switch terminals on the Low Voltage Connection Board.</li> </ul>
Flow Switch/ LWCO (will require a manual reset once condition has been corrected. Press the RESET button on the SMART SYSTEM display to reset.)	- Either the optional flow switch or the optional low water cutoff is not making.	<ul style="list-style-type: none"> <li>• Check boiler pump operation on a call for heat.</li> <li>• Check for closed valves or obstructions in the boiler piping.</li> <li>• Verify system is full of water and all air has been purged from the system.</li> <li>• Check for loose or misplaced jumpers if flow switch or LWCO is not installed.</li> </ul>
	- Blown fuse.	<ul style="list-style-type: none"> <li>• Replace fuse F3 on the control board, see page 33 of this manual.</li> </ul>
Blocked Drain SW (will require a manual reset once condition has been corrected. Press the RESET button on the SMART SYSTEM display to reset.)	The blocked drain switch has detected excessive condensate build up inside the unit.	<ul style="list-style-type: none"> <li>• Check condensate tube from unit to floor drain for proper installation and obstructions.</li> <li>• Inspect condensate trap for blockage. Clean if necessary.</li> <li>• Check for loose wiring connection at wire harness plug.</li> <li>• Bad blocked drain switch. Replace switch.</li> </ul>

### 3 Troubleshooting

**Table 3-4** (continued from previous page) *Troubleshooting Chart - Fault Messages Displayed on Boiler Interface*

FAULT	DESCRIPTION	CORRECTIVE ACTION
<p><b>APS / HEX Temp Sw Open</b> (will require a manual reset once the condition has been corrected. Press the RESET button on the SMART SYSTEM display to reset.)</p>	<p>Either the air pressure switch contacts are open, or the O-temp heat exchanger switch has opened.</p>	<p style="text-align: center;"><b>APS:</b></p> <ul style="list-style-type: none"> <li>• Check the wiring connections to switch. Wires should be connected to the common and normally closed terminals.</li> <li>• Air intake lengths exceed the maximum allowed lengths. Refer to Section 3 - General Venting of the Knight Installation and Operation Manual for proper lengths.</li> <li>• Check for obstruction or blockage in the air intake pipes or at terminations.</li> <li>• Check reference hoses connected to the air pressure switch for blockage or obstruction.</li> <li>• Inspect the burner. Reference page 31 of this manual for removal and cleaning procedures. Replace if necessary.</li> <li>• Inspect the heat exchanger. Reference page 32 of this manual for removal and cleaning procedures. Replace if necessary.</li> <li>• Faulty air pressure switch. Replace switch.</li> </ul> <hr/> <p style="text-align: center;"><b>O-TEMP HEX SWITCH (Applies to the 286 Model Only):</b></p> <ul style="list-style-type: none"> <li>• Inspect the back of the inner combustion chamber at burner level for refractory breakdown / missing. Replace heat exchanger if refractory is broken and unit has fired.</li> <li>• Check continuity across two contacts. Wires should be connected at both poles of the normally closed switch.</li> <li>• Faulty O-Temp HEX Switch. Replace switch.</li> </ul>
<p><b>Anti-cycling</b></p>	<p>The main control board has received a call for heat too quickly after the previous call for heat has ended.</p>	<ul style="list-style-type: none"> <li>• The control board will release the call for heat after a set time period.</li> <li>• The control board will release the call for heat if the outlet temperature drops too quickly.</li> </ul>
<p><b>Flame Fail Ign</b> (will require a manual reset once the condition has been corrected. Press the RESET button on the SMART SYSTEM display to reset.)</p>	<p>The unit has failed to prove main burner ignition after four (4) attempts.</p>	<ul style="list-style-type: none"> <li>• Check wiring harness connection at the gas valve and at the main control board.</li> <li>• Inspect spark electrode and associated wiring for damage and connection. Reference page 31 of this manual for removal and cleaning procedures. Replace if necessary.</li> <li>• Check for proper electrical grounding of the unit.</li> <li>• Check incoming supply gas pressure. Natural gas pressures should be between 4 - 14 inches w.c. and LP gas pressures should be between 8 - 14 inches w.c. Refer to Section 7 - Gas Connections of the Knight Boiler Installation and Operation Manual for detailed information concerning the gas supply.</li> </ul>

### 3 Troubleshooting *(continued)*

**Table 3-4** *(continued from previous page) Troubleshooting Chart - Fault Messages Displayed on Boiler Interface*

FAULT	DESCRIPTION	CORRECTIVE ACTION
<p>Flame Fail Ign (cont'd) (will require a manual reset once the condition has been corrected. Press the RESET button on the SMART SYSTEM display to reset.)</p>	<p>The unit has failed to prove main burner ignition after four (4) attempts.</p>	<ul style="list-style-type: none"> <li>• Verify that the plastic hose from the gas valve to the air inlet is connected and is not damaged.</li> <li>• Verify that the vent/air intake pipes are correctly installed and that there are no obstructions.</li> <li>• Check for 24 vac to the gas valve at the 2-pin connection on the side of the main control board during the ignition attempt. If no voltage is present, replace the main control board.</li> <li>• If 24 vac is present at the main control board, check the wiring between the main control board and the gas valve. Replace the wiring if necessary.</li> <li>• If 24 vac is present, check the outlet of the valve to ensure the valve is flowing gas. With a manometer connected to the outlet tap of the gas valve, when the unit is in the prepurge period, there should be a negative pressure present. When the valve is energized a change in pressure should occur. If the pressure change does not occur, the gas valve is not opening. Replace the gas valve.</li> <li>• Inspect flame sensor and associated wiring. Reference page 31 of this manual for removal and cleaning procedures. Replace if necessary.</li> <li>• Inspect and clean the heat exchanger as necessary. Reference page 32 of this manual for cleaning procedures.</li> <li>• Inspect the burner. Reference page 31 of this manual for removal and cleaning procedures. Replace if necessary.</li> <li>• Replace the main control board.</li> </ul>
<p>Flame Sequence (will require a manual reset once the condition has been corrected. Press the RESET button on the SMART SYSTEM display to reset.)</p>	<p>The flame detector circuit is seeing a flame signal while no flame is present.</p>	<ul style="list-style-type: none"> <li>• Check supply voltage for proper polarity.</li> <li>• Check external wiring for voltage feedback.</li> <li>• Check the flame rod and make sure it is clean.</li> <li>• Check the internal wiring for bad connections.</li> <li>• Replace main control board.</li> </ul>

### 3 Troubleshooting *(continued)*

**Table 3-4** (continued from previous page) *Troubleshooting Chart - Fault Messages Displayed on Boiler Interface*

FAULT	DESCRIPTION	CORRECTIVE ACTION
Outlet ARHL	The outlet water temperature has exceeded the setting of the automatic reset high limit.	<ul style="list-style-type: none"> <li>• Adjust the set point of the auto reset limit to a higher setting up to a maximum of 200°F. Reference the Knight Installation and Operation Manual for adjusting procedures.</li> <li>• Verify that the system is full of water and that all air has been properly purged from the system.</li> <li>• Verify that the boiler is piped properly into the heating system. Refer to Section 6 - Hydronic Piping of the Knight Boiler Installation and Operation Manual for the proper piping methods for the Knight boiler.</li> <li>• Check 120 vac to boiler pump motor on a call for heat. If voltage is not present, check wiring back to the main control board.</li> <li>• Replace the main control board if necessary.</li> <li>• If 120 vac is present on a call for heat and the boiler pump is not operating, replace the pump.</li> <li>• If the system pump is a variable speed pump, ensure that the system flow is not less than the boiler flow.</li> <li>• If operating on something other than an outlet sensor, check temperature setting of the main control board.</li> <li>• If the optional manual reset high limit has tripped, check setting of the device.</li> <li>• Check resistance of water sensors and compare to Table 3-2A on page 35 of this manual. Replace sensor if necessary.</li> <li>• Replace high limit.</li> </ul>
Outlet MRHL (will require a manual reset once the condition has been corrected. Press the RESET button on the SMART SYSTEM display to reset.)	The outlet water temperature has exceeded the setting of the manual reset high limit.	<ul style="list-style-type: none"> <li>• Adjust the set point of the manual reset limit to a higher setting up to a maximum of 210°F. Reference the Knight Boiler Installation and Operation Manual for adjusting procedures.</li> <li>• Verify that the system is full of water and that all air has been properly purged from the system.</li> <li>• Verify that the boiler is piped properly into the heating system. Refer to Section 6 - Hydronic Piping of the Knight Boiler Installation and Operation Manual for the proper piping methods for the Knight boiler.</li> <li>• Check 120 vac to boiler pump motor on a call for heat. If voltage is not present, check wiring back to the main control board.</li> </ul>



### 3 Troubleshooting *(continued)*

**Table 3-4** *(continued from previous page) Troubleshooting Chart - Fault Messages Displayed on Boiler Interface*

FAULT	DESCRIPTION	CORRECTIVE ACTION
<p>Outlet MRHL (cont'd) (will require a manual reset once the condition has been corrected. Press the RESET button on the SMART SYSTEM display to reset.)</p>	<p>The outlet water temperature has exceeded the setting of the manual reset high limit.</p>	<ul style="list-style-type: none"> <li>• Replace the main control board if necessary.</li> <li>• If 120 vac is present on a call for heat and the boiler pump is not operating, replace the pump.</li> <li>• If the system pump is a variable speed pump, ensure that the system flow is not less than the boiler flow.</li> <li>• If operating on something other than an outlet sensor, check temperature setting of the main control board.</li> <li>• If the optional manual reset high limit has tripped, check setting of the device.</li> <li>• Check resistance of water sensors and compare to Table 3-2A on page 35 of this manual. Replace sensor if necessary.</li> <li>• Replace high limit.</li> </ul>
<p>Fan Low/High OR Fan Speed Low/ High (will require a manual reset once the condition has been corrected. Press the RESET button on the SMART SYSTEM display to reset.)</p>	<p>The actual fan RPM is 30% lower than what is being called for.</p>	<ul style="list-style-type: none"> <li>• Vent/air intake lengths exceed the maximum allowed lengths. Refer to Section 3 - General Venting of the Knight Boiler Installation and Operation Manual for proper lengths.</li> <li>• Check for obstruction or blockage in the vent/air intake pipes or at terminations.</li> <li>• Check the wiring connections at the fan and at the main control board.</li> <li>• Replace the fan.</li> <li>• Replace the main control board.</li> </ul>
	<p>Blown fuse.</p>	<ul style="list-style-type: none"> <li>• Replace fuse F2 on the control board, see page 33 of this manual.</li> </ul>
<p>Sensor Open (will require a manual reset once the condition has been corrected. Press the RESET button on the SMART SYSTEM display to reset.)</p>	<p>Either the inlet water or outlet water temperature sensor has been disconnected.</p>	<ul style="list-style-type: none"> <li>• Check the sensors and their associated wiring. Repair or replace the sensor or wiring if damaged.</li> <li>• Measure the resistance of the sensors and compare the resistance to the tables on page 35 of this manual.</li> <li>• Replace the sensor if necessary.</li> </ul>

## 3 Troubleshooting

**Table 3-4** (continued from previous page) *Troubleshooting Chart - Fault Messages Displayed on Boiler Interface*

FAULT	DESCRIPTION	CORRECTIVE ACTION
<p>Sensor Shorted (will require a manual reset once the condition has been corrected. Press the RESET button on the SMART SYSTEM display to reset.)</p>	<p>Either the inlet water or outlet water temperature sensor has been shorted.</p>	<ul style="list-style-type: none"> <li>• Check the sensors and their associated wiring. Repair or replace the sensor or wiring if damaged.</li> <li>• Measure the resistance of the sensors and compare the resistance to the tables on page 35 of this manual.</li> <li>• Replace the sensor if necessary.</li> </ul>
<p>Louver Proving Sw (will require a manual reset once the condition has been corrected. Press the RESET button on the SMART SYSTEM display to reset.)</p>	<p>An optional remote proving switch is not making.</p>	<ul style="list-style-type: none"> <li>• Check function of remote devices.</li> <li>• Check for loose or misplaced jumper if auxiliary proving switch is not installed.</li> </ul>
<p>Inlet Sensor Fault (will require a manual reset once the condition has been corrected. Press the RESET button on the SMART SYSTEM display to reset.)</p>	<p>The control reads the inlet sensor as open or shorted.</p>	<ul style="list-style-type: none"> <li>• Check wiring to sensor. Make sure wiring is connected and not damaged. Reconnect / repair wiring if necessary.</li> <li>• Measure the resistance of the sensor and compare to the resistance in Table 3-2A on page 35 of this manual. Replace sensor if necessary.</li> <li>• Replace control module.</li> </ul>
<p>Outlet Sensor Fault (will require a manual reset once the condition has been corrected. Press the RESET button on the SMART SYSTEM display to reset.)</p>	<p>The control reads the inlet sensor as open or shorted.</p>	<ul style="list-style-type: none"> <li>• Check wiring to sensor. Make sure wiring is connected and not damaged. Reconnect / repair wiring if necessary.</li> <li>• Measure the resistance of the sensor and compare to the resistance in Table 3-2C on page 35 of this manual. Replace sensor if necessary.</li> <li>• Replace control module.</li> </ul>
<p>Outlet Temp Diff (will require a manual reset once the condition has been corrected. Press the RESET button on the SMART SYSTEM display to reset.)</p>	<p>The control module reads an excessive temperature difference between the two sensors.</p>	<ul style="list-style-type: none"> <li>• Check wiring to sensor. Make sure wiring is connected and not damaged. Reconnect / repair wiring if necessary.</li> <li>• Measure the resistance of the sensor and compare to the resistance in Table 3-2C on page 35 of this manual. Replace sensor if necessary.</li> <li>• Restore control parameter defaults from optional PC software.</li> <li>• Replace control module.</li> </ul>
<p>Outdoor Sensor Fault (will be displayed until condition has been corrected)</p>	<p>The control reads the outdoor sensor as open or shorted.</p>	<ul style="list-style-type: none"> <li>• Check wiring to sensor. Make sure wiring is connected and not damaged. Reconnect / repair wiring if necessary.</li> <li>• Measure the resistance of the sensor and compare to the resistance in Table 3-2B on page 35 of this manual.</li> <li>• Replace sensor if necessary.</li> </ul>

### 3 Troubleshooting *(continued)*

**Table 3-4** (continued from previous page) *Troubleshooting Chart - Fault Messages Displayed on Boiler Interface*

FAULT	DESCRIPTION	CORRECTIVE ACTION
<p>Flue Sensor Fault (will require a manual reset once the condition has been corrected. Press the RESET button on the SMART SYSTEM display to reset.)</p>	<p>The control reads the flue sensor as open or shorted.</p>	<ul style="list-style-type: none"> <li>• Check wiring to sensor. Make sure wiring is connected and not damaged. Reconnect / repair wiring if necessary.</li> <li>• Measure the resistance of the sensor and compare to the resistance in Table 3-2D on page 35 of this manual. Replace the sensor if necessary.</li> <li>• Replace control module.</li> </ul>
<p>Flue Temp Diff (will require a manual reset once the condition has been corrected. Press the RESET button on the SMART SYSTEM display to reset.)</p>	<p>The control module reads an excessive temperature difference between the two sensors.</p>	<ul style="list-style-type: none"> <li>• Check wiring to sensor. Make sure wiring is connected and not damaged. Reconnect / repair wiring if necessary.</li> <li>• Measure the resistance of the sensor and compare to the resistance in Table 3-2D on page 35 of this manual. Replace sensor if necessary.</li> <li>• Restore control parameter defaults from optional PC software.</li> <li>• Replace control module.</li> </ul>
<p>Flue Temp Limit (will require a manual reset once the condition has been corrected. Press the RESET button on the SMART SYSTEM display to reset.)</p>	<p>The stack temperature has exceeded the Flue Temp Limit set parameters.</p>	<ul style="list-style-type: none"> <li>• Inspect the heat exchanger. Reference page 32 of this manual for the procedure on how to clean the flue side of the heat exchanger.</li> <li>• Inspect the flue sensor and associated wiring. Measure the resistance of the flue sensor and compare to Table 3-2D on page 35 of this manual. Replace the sensor if necessary.</li> <li>• Verify that the vent/air intake pipes are properly installed and that there are no obstructions.</li> <li>• Replace the main control board.</li> </ul>
<p>Fatal Error</p>	<p>The control module has detected parameter settings that are out of range.</p>	<ul style="list-style-type: none"> <li>• Restore the parameter defaults from the optional PC software.</li> <li>• Replace control module.</li> </ul>
<p>Memory Error</p>	<p>A lockout occurs at the same time as a power outage.</p>	<ul style="list-style-type: none"> <li>• Reset control module.</li> </ul>

### 3 Troubleshooting

**Table 3-4** (continued from previous page) *Troubleshooting Chart - Fault Messages Displayed on Boiler Interface*

FAULT	DESCRIPTION	CORRECTIVE ACTION
Flue Temp High	The stack temperature has exceeded the set parameters for the boiler.	<ul style="list-style-type: none"> <li>• Inspect the heat exchanger. Reference page 32 of this manual for the procedure on how to clean the flue side of the heat exchanger.</li> <li>• Inspect the flue sensor and associated wiring. Measure the resistance of the flue sensor and compare to Table 3-2D on page 35 of this manual. Replace the sensor if necessary.</li> <li>• Verify that the vent/air intake pipes are properly installed and that there are no obstructions.</li> <li>• Replace the main control board.</li> </ul>
Delta T High	The temperature rise across the heat exchanger has exceeded the set parameters for the boiler.	<ul style="list-style-type: none"> <li>• Verify that the system is full of water and that all air has been properly purged from the system.</li> <li>• Verify that the boiler is piped properly into the heating system. Refer to Section 6 - Hydronic Piping of the Knight Boiler Installation and Operation Manual for the proper piping methods for the Knight boiler.</li> <li>• Check for 120 vac to the boiler pump motor on a call for heat. If voltage is not present, check the wiring back to the main control board. Replace the main control board if necessary.</li> <li>• If 120 vac is present on a call for heat and the boiler pump is not operating, replace the pump.</li> <li>• Verify that the boiler pump is set to the proper speed or that the pump is the proper size. Reference Section 6 - Hydronic Piping of the Knight Boiler Installation and Operation Manual for boiler pump specifications.</li> </ul>
Outlet Temp High	Outlet water temperature has exceeded the maximum outlet water temperature.	<ul style="list-style-type: none"> <li>• Verify that the system is full of water and that all air has been properly purged from the system.</li> <li>• Verify that the boiler is piped properly into the heating system. Refer to Section 6 - Hydronic Piping of the Knight Boiler Installation and Operation Manual for the proper piping methods for the Knight boiler.</li> <li>• Check for 120 vac to the boiler pump motor on a call for heat. If voltage is not present, check wiring back to the main control board. Replace the main control board if necessary.</li> <li>• If 120 vac is present on a call for heat and the boiler pump is not operating, replace the pump.</li> </ul>

### 3 Troubleshooting *(continued)*

**Table 3-4** *(continued from previous page) Troubleshooting Chart - Fault Messages Displayed on Boiler Interface*

FAULT	DESCRIPTION	CORRECTIVE ACTION
Outlet Temp High (continued)	Outlet water temperature has exceeded the maximum outlet water temperature.	<ul style="list-style-type: none"> <li>• Verify that the boiler pump is set to the proper speed or that the boiler pump is the proper size. Reference Section 6 - Hydronic Piping of the Knight Boiler Installation and Operation Manual for boiler pump specifications.</li> <li>• Replace the main control board.</li> </ul>
Rem Ctrl Flt	External control is cycling too often.	<ul style="list-style-type: none"> <li>• Check set point of the external control.</li> <li>• Check the wiring between the external control and the unit.</li> <li>• Replace the control.</li> </ul>
Parameters Progr (will require a manual reset once the condition has been corrected. Press the RESET button on the SMART SYSTEM display to reset.)	After downloading parameters from a laptop, the main control board must be reset.	<ul style="list-style-type: none"> <li>• Press the ENTER/RESET button on the SMART SYSTEM display panel.</li> </ul>
Service Blk	While the unit is in Service Mode, the outlet temperature has exceeded 185°F.	<ul style="list-style-type: none"> <li>• Establish a heating load to remove the heat from the boiler loop.</li> <li>• Verify that the system is full of water and that all air has been properly purged from the system.</li> <li>• Verify that the boiler is piped properly into the heating system. Refer to Section 6 - Hydronic Piping of the Knight Boiler Installation and Operation Manual for the proper piping methods for the Knight boiler.</li> <li>• Check 120 vac to the boiler pump motor on a call for heat. If voltage is not present, check the wiring back to the main control board. Replace the main control board if necessary.</li> <li>• If 120 vac is present on a call for heat and the boiler pump is not operating, replace the pump.</li> <li>• Verify that the boiler pump is set to the proper speed or that the boiler pump is the proper size. Reference Section 6 - Hydronic Piping of the Knight Boiler Installation and Operation Manual for boiler pump specifications.</li> </ul>

## 3 Troubleshooting

**Table 3-4** (continued from previous page) *Troubleshooting Chart - Fault Messages Displayed on Boiler Interface*

FAULT	DESCRIPTION	CORRECTIVE ACTION
Low 24 vac	120 vac input to the main control board has dropped below 80 vac.	<ul style="list-style-type: none"> <li>• Check 120 vac supply to the transformer.</li> <li>• Check wiring connections at the low voltage terminal strip.</li> <li>• Check the wire size/length to remote devices.</li> <li>• Replace the transformer.</li> </ul>
Watch Dog Error	The main control board has detected an internal fault.	<ul style="list-style-type: none"> <li>• Replace the main control board.</li> </ul>
Write EEPROM	The main control board has detected an internal fault.	<ul style="list-style-type: none"> <li>• Replace the main control board.</li> </ul>
CRC Parameters	The main control board has detected an internal fault.	<ul style="list-style-type: none"> <li>• Replace the main control board.</li> </ul>
No Error Stored	The main control board has detected an internal fault.	<ul style="list-style-type: none"> <li>• Replace the main control board.</li> </ul>

### Combustion Analysis Procedure

1. Turn the main power off to the boiler by placing the "On/Off" switch in the OFF position.
2. Remove the flue temperature sensor from the flue pipe connection. **Note:** Combustion measurements will be made at this point.
3. Turn the main power on to the boiler by placing the "On/Off" switch in the ON position.
4. Place the boiler into the active position by pressing the RIGHT SELECT [ON] key (see page 7).
5. Locate the pinhole button below the RESET button on the display board (see page 7). Insert a thin wire (such as a paper clip) into the hole and press the button once and hold for 5 seconds to place the boiler into Service Mode. In Service Mode the boiler will fire at ignition speed and will then modulate up to full fire.
6. Insert the probe from a combustion analyzer into the hole left by the removal of the flue temperature sensor.
7. Once the boiler has modulated up to full fire, measure the combustion. The values should be in the range listed in Table 3-5 above. The CO levels should be less than 150 ppm for a properly installed unit.

If the combustion is not within the specified range, reference the chart below for possible causes and corrective actions.

**Table 3-5** *Flue Products*

Natural Gas		Propane	
CO <sub>2</sub>	O <sub>2</sub>	CO <sub>2</sub>	O <sub>2</sub>
8.0% - 10%	3.0% - 6.5%	9.0% - 11%	4.1% - 6.9%

8. Once the combustion analysis is complete, test the safety shutoff device by turning the manual shutoff switch to the OFF position and ensuring that the boiler shuts down and registers an alarm. Turn the manual shutoff switch to the ON position, reset the control, and return to Service Mode.
9. Turn the main power off to the boiler and replace the flue temperature sensor into the flue pipe connection.
10. Place the boiler back into normal operation.

**⚠ WARNING**

You must replace the flue gas temperature sensor to prevent flue gas spillage into the room. Failure to comply could result in severe personal injury, death, or substantial property damage.

## 3 Troubleshooting *(continued)*

**Table 3-6** Troubleshooting Chart - Combustion Levels

POSSIBLE CAUSE	CORRECTIVE ACTION
<b>Vent/Air Intake Length or Obstruction</b>	<ul style="list-style-type: none"> <li>Refer to Section 3 - General Venting of the Knight Boiler Installation and Operation Manual for the proper venting and air intake methods for the Knight boiler.</li> <li>Check for obstructions at the vent/air intake terminals.</li> </ul>
<b>Gas Supply Pressure</b>	<ul style="list-style-type: none"> <li>Refer to Section 7 - Gas Connections of the Knight Boiler Installation and Operation Manual for the proper gas supply for the Knight boiler.</li> </ul>
<b>Dirty/Damaged Burner</b>	<ul style="list-style-type: none"> <li>Refer to page 31 of this manual for burner removal and cleaning procedures.</li> <li>Replace burner if necessary.</li> </ul>
<b>Gas Valve Adjustment</b>	<ul style="list-style-type: none"> <li>Refer to this page for the gas valve adjustment procedure.</li> </ul>

### Gas valve adjustment procedure

If adjustment of the gas valve is deemed necessary, use the following procedure:

Locate the throttle adjustment screw on the side of the venturi valve (FIG. 3-2). Using a screwdriver, turn the screw a 1/4 turn counterclockwise to increase CO<sub>2</sub> levels or a 1/4 turn clockwise to decrease CO<sub>2</sub> levels. After performing one adjustment on the valve, follow the Combustion Analysis Procedure on page 46 of this manual to measure the combustion.

If combustion is still not within the specified range, repeat the procedure. This procedure **SHOULD NOT** be performed more than four (4) times. If after four (4) adjustments and the combustion is still not within the specified range, revisit the possible causes in Table 3-6 or replace the gas valve.

**Figure 3-2** Gas Valve Adjustment

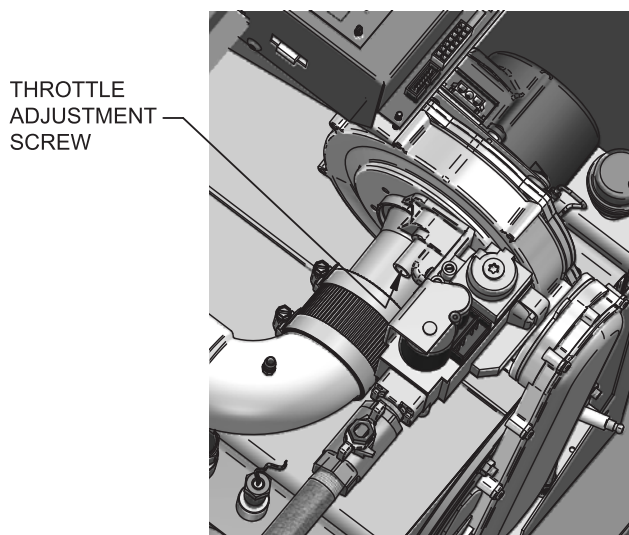

**Revision Notes:** Revision A (ECO #C05747) initial release. Reflects the new model numbers for the Knight upgrade.

Revision B (ECO #C06234) reflects changes made to the Service Notification parameter.

Revision C (ECO #C07981) reflects changes made to the parameter table, parameter descriptions, updates to the troubleshooting chart, and the addition of the O-temp HEX switch.

Revision D (ECO ##C09197) reflects updates made to the SMART SYSTEM control (ECR #R04523).

Revision E (ECO #C10143) reflects the removal of the "GV/RELAY FAIL" FAULT (ECR #R05239) and updates made to the ignition timing information.

Revision F (ECO #C11102) reflects outdoor air reset updates.